

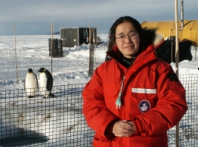

Lecture 33. Aerosol Lidar (2)

Elastic-Scattering, Raman, HSRL

- ❑ Elastic-scattering lidar for aerosol detection
- ❑ Single-channel vs multi-channel aerosol lidars
- ❑ Measurement of aerosol extinction from multi-channel lidar (Raman lidar and HSRL)
- ❑ High Spectral Resolution Lidar for aerosol detection
- ❑ University of Wisconsin HSRL example
- ❑ Comparison of aerosol lidar technique
- ❑ Summary



Elastic-Scattering Lidar for Aerosols

Co-axial Lidar

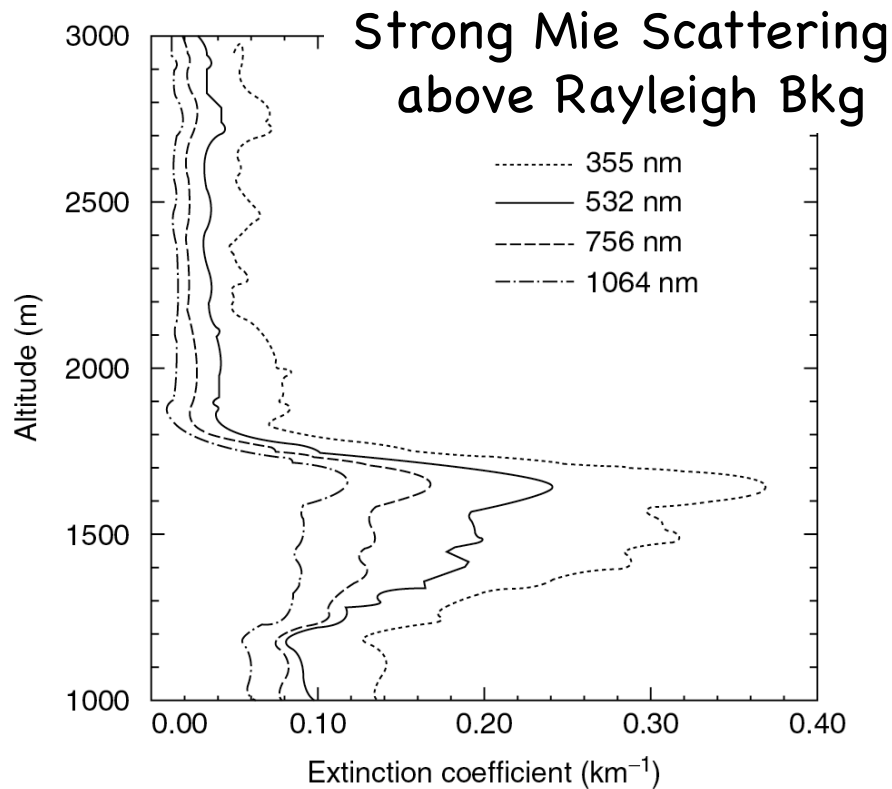
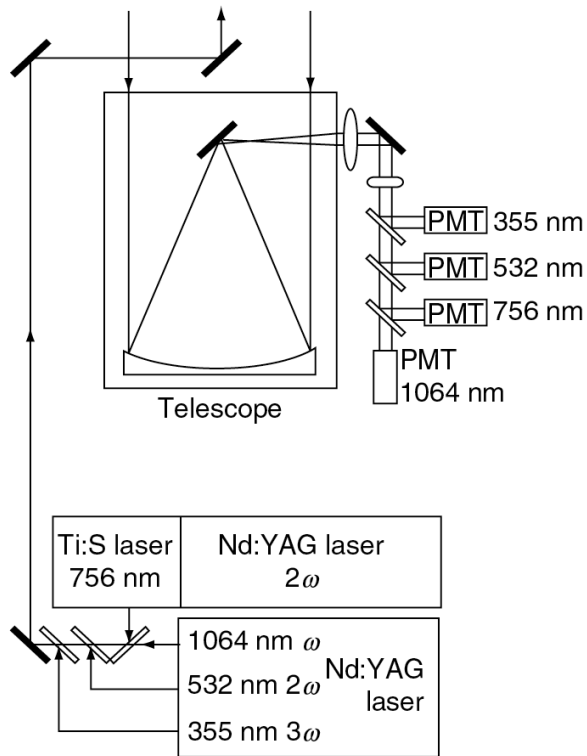

Block diagram of four-wavelength lidar.

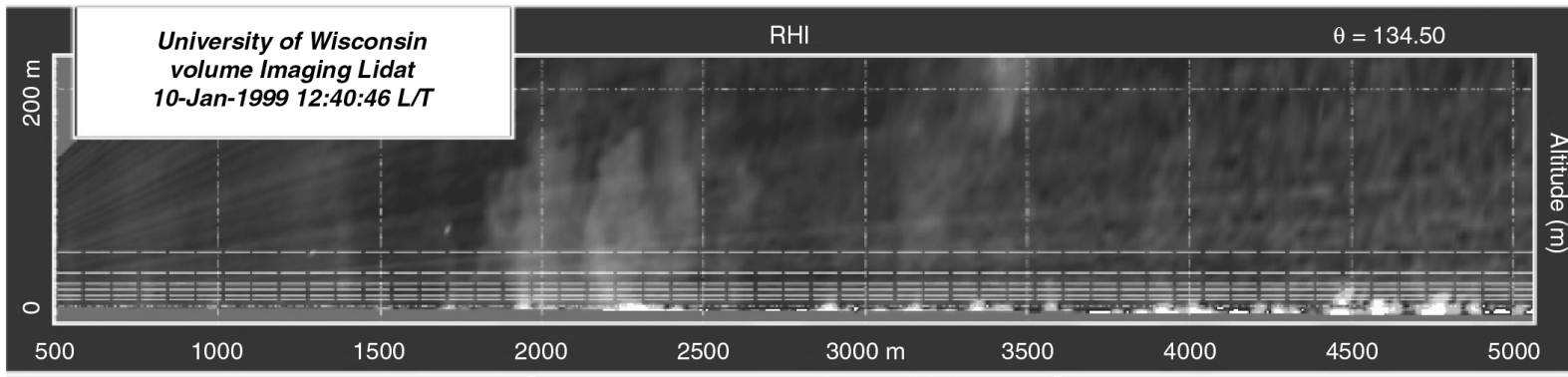



Elastic-Scattering for Lower Atmos

- Lidar equation for elastic backscatter by air molecules and aerosols

$$P(R) = \frac{E_0 \eta}{R^2} O(R) \beta(R) \exp\left[-2 \int_0^R \alpha(r) dr\right]$$

$O(R)$ - overlap between laser and FOV

$\beta(R)$ - backscatter coefficient ($\text{km}^{-1}\text{sr}^{-1}$)

$\alpha(R)$ - extinction coefficient (km^{-1})

- Backscatter and extinction are contributed by aerosols and molecules

$$\beta(R) = \beta_{aer}(R) + \beta_{mol}(R)$$

$$\alpha(R) = \alpha_{aer}(R) + \alpha_{mol}(R)$$

Index aer refer to aerosol particles

Index mol refer to air molecules

- Combining above equations, we obtain

$$S(R) = P(R) R^2 = E_0 \eta_L [\beta_{aer}(R) + \beta_{mol}(R)] \exp\left[-2 \int_0^R [\alpha_{aer}(r) + \alpha_{mol}(r)] dr\right]$$

Note: backscatter is local effect while extinction is integrated effect

- Recall the Rayleigh scattering from air molecules $\beta_{mol}(R)$ can be determined from atmosphere temperature and pressure

$$\beta_{mol}(\lambda, z_R) = 2.938 \times 10^{-32} \frac{P(z_R)}{T(z_R)} \cdot \frac{1}{\lambda^{4.0117}}$$

z_R is altitude for range R

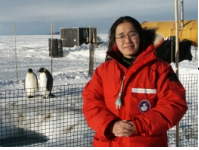

Elastic-Scattering Cont' d

- Ignore the molecular absorption, then the extinction by air molecules is the integration of molecular angular scattering coefficient through the entire 4π solid angles. Rayleigh scattering is anisotropic

$$\beta(\theta) = \frac{\beta_T}{4\pi} P(\theta) = \frac{\beta_T}{4\pi} \times 0.7629 \times (1 + 0.9324 \cos^2 \theta)$$

$$\alpha_{mol}(R) = \beta_T = \frac{8\pi}{3} \cdot \beta(R, \pi)$$

- Define molecule extinction-to-backscatter ratio (lidar ratio) as

$$L_{mol} = \frac{\alpha_{mol}(R)}{\beta_{mol}(R)} = \frac{8\pi}{3} sr$$

The lidar ratio for molecule is range independent

- Thus, among the four parameters $\beta_{mol}(R)$, $\beta_{aer}(R)$, $\alpha_{mol}(R)$, $\alpha_{aer}(R)$, two are known, and the other two $\beta_{aer}(R)$ and $\alpha_{aer}(R)$ are unknown.

- Define the lidar ratio for aerosols (extinction-to-backscatter ratio)

$$L_{aer}(R) = \frac{\alpha_{aer}(R)}{\beta_{aer}(R)}$$

- Define a variable $Y(R)$ as

$$Y(R) = L_{aer}(R) [\beta_{aer}(R) + \beta_{mol}(R)]$$

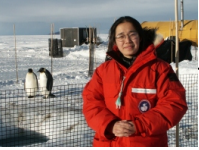

Derive Aerosol Backscatter and Extinction in Lower Atmosphere

- Substitute lidar ratios and $Y(R)$ into the lidar equation for $S(R)$,

$$S(R)L_{aer}(R)\exp\left\{-2\int_0^R[L_{aer}(r)-L_{mol}]\beta_{mol}(r)dr\right\}=E_0\eta_L Y(R)\exp\left[-2\int_0^R Y(r)dr\right]$$

- Taking the logarithms of both sides of above equation and differentiating them with respect to R , we obtain

$$\frac{d\ln\left(S(R)L_{aer}(R)\exp\left\{-2\int_0^R[L_{aer}(r)-L_{mol}]\beta_{mol}(r)dr\right\}\right)}{dR}=\frac{1}{Y(R)}\frac{dY(R)}{dR}-2Y(R)$$

- This is a Bernoulli equation, and can be solved for the following boundary condition

$$Y(R_0)=L_{aer}(R_0)[\beta_{aer}(R_0)+\beta_{mol}(R_0)]$$

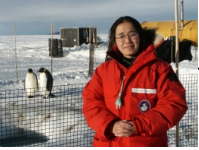

Klett Method

- By solving the Bernoulli equation, we obtain the backscatter coefficient

$$\beta_{aer}(R) + \beta_{mol}(R) = \frac{S(R) \exp\left\{-2 \int_{R_0}^R [L_{aer}(r) - L_{mol}] \beta_{mol}(r) dr\right\}}{\frac{S(R_0)}{\beta_{aer}(R_0) + \beta_{mol}(R_0)} - 2 \int_{R_0}^R L_{aer}(r) S(r) T(r, R_0) dr}$$

where

$$T(r, R_0) = \exp\left\{-2 \int_{R_0}^r [L_{aer}(r') - L_{mol}] \beta_{mol}(r') dr'\right\}$$

- The aerosol extinction coefficient can be estimated by

$$\alpha_{aer}(R) = L_{aer}(R) \beta_{aer}(R)$$

- The solution for the Bernoulli equation can be integrated by starting from reference range R_0 , which may be either the near end ($R > R_0$, forward integration), or the remote end ($R < R_0$, backward integration).

- Numerical stability is only given by the backward integration, which is called Klett method [1981].

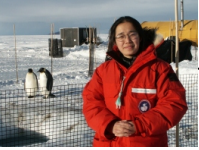

How Reliable is Single-Channel Lidar?

- ❑ The above method is basically using one lidar equation to determine two unknown parameters. Its accuracy critically relies on the input parameter $L_{aer}(R)$ - lidar ratio for aerosol.
- ❑ However, this quantity depends on the microphysical, chemical and morphological properties of the particles, and varies strongly with height, especially when marine, anthropogenic (urban, biomass burning), and desert dust particles or mixtures of these are present in layers above each other. Even in the well-mixed layer, the lidar ratio is not constant with height because relative humidity increases with height.

Aerosol type	Lidar ratio
Marine particles	20-35 sr
Saharan dust	50-80 sr
Less absorbing urban particles	35-70 sr
Absorbing particles from biomass burning	70-100 sr

- ❑ Variations between 20-100 sr make it practically impossible to estimate trustworthy extinction profiles from single-channel data in lower atmos.

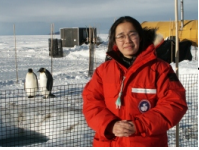

Multi-Channel Lidar for Aerosols

- ❑ To infer aerosol extinction more trustworthy, the key is to add additional channels to provide additional information. At least, two channels of lidar profiles are needed. Raman lidar and HSRL are two major solutions to this problem.
- ❑ One method is the measurement of two lidar profiles in one of which the aerosol scattering is zero $\beta_{aer} = 0$. This is the case in Raman lidar. Only molecules, not aerosols, contribute to the inelastic Raman backscatter profile produced by molecular nitrogen or oxygen.
 - (1) The elastic lidar return is affected by both aerosol extinction α_{aer} and aerosol backscatter β_{aer} .
 - (2) Raman lidar return is affected by aerosol extinction α_{aer} alone, as aerosol scattering β_{aer} is at a different wavelength than the Raman return wavelength, so won't be received by the Raman channel.
- ❑ Another method is the high-spectral-resolution lidar (HSRL) that has two channels - one to measure pure molecular scattering, and another to measure the combination of aerosol and molecular scattering.



Raman Lidar and HSRL

□ Raman lidar measures

- (1) elastic scattering from aerosols & molecules,
- (2) inelastic (Raman) scattering by N_2 or O_2 molecules.

For example, if 532 nm laser is Raman shifted by N_2 , the V-R Raman signal is at 607 nm.

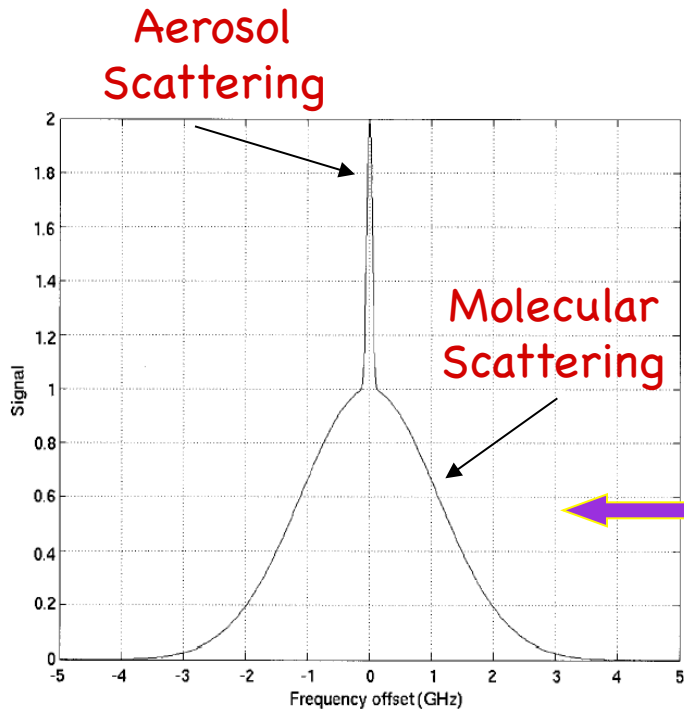

Fig. 5.1. Spectral profile of backscattering from a mixture of molecules and aerosols for a temperature of 300 K. The spectral width of the narrow aerosol return is normally determined by the line width of the transmitting laser.

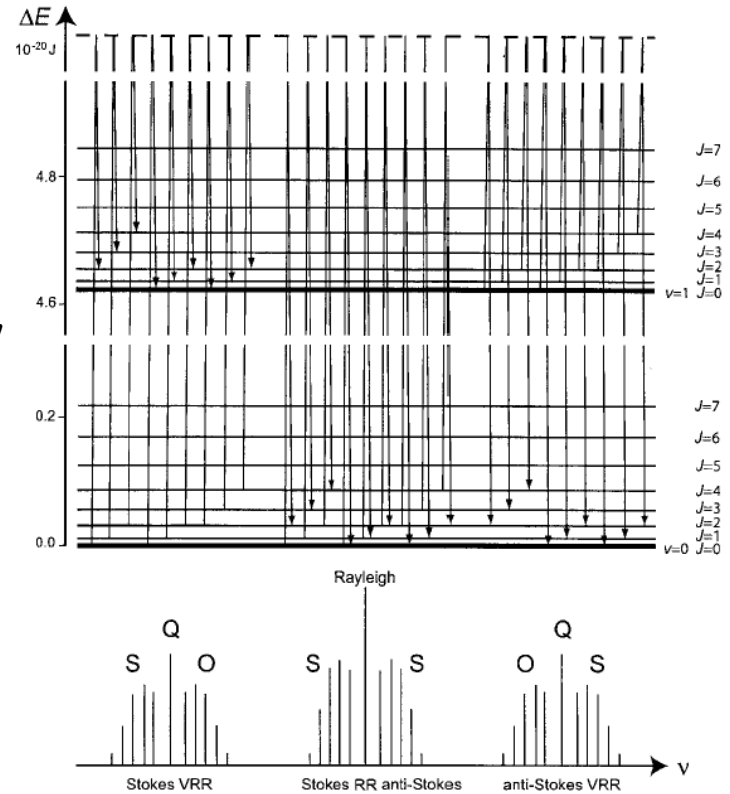

Fig. 9.1. Vibration-rotation energy levels of the N_2 molecule, Raman transitions, and resulting spectrum.

□ High-Spectral-Resolution-Lidar (HSRL) is to measure the molecule scattering separately from the aerosol scattering, utilizing the different spectral distribution of the Rayleigh and Mie scattering.



Derive Extinction from Raman/HSRL

- For the pure **R**ayleigh channel in HSRL or the **R**aman channel

$$P(R, \lambda_{Ra}) = \frac{E_0 \eta_{\lambda_{Ra}}}{R^2} O(R, \lambda_{Ra}) \beta_{Ra}(R, \lambda_0) \exp \left\{ - \int_0^R [\alpha(r, \lambda_0) + \alpha(r, \lambda_{Ra})] dr \right\}$$

On the way up
On the way down

where P is the power of return signal from Rayleigh or Raman scattering,
 R is range and λ_0 is the outgoing laser wavelength,
 λ_{Ra} is the wavelength of Rayleigh or Raman scattering,
 E_0 is the transmitted laser pulse energy,
 $\eta_{\lambda_{Ra}}$ is the lidar optical and detection efficiency at wavelength λ_{Ra} ,
 O is the overlapping function between laser and receiver FOV,
 β_{Ra} is the backscatter coefficient of Rayleigh or Raman scattering,
 $\alpha(\lambda_0)$ is the extinction on the way up to the backscatter region,
 $\alpha(\lambda_{Ra})$ is the extinction on the way back to the lidar.

For HSRL, $\lambda_0 = \lambda_{Ra}$ (elastic); For Raman, $\lambda_0 \neq \lambda_{Ra}$ (inelastic)



Derive Extinction from Raman/HSRL

- The backscatter coefficient of Rayleigh or Raman scattering from air molecules can be calculated as

$$\beta_{Ra}(R, \lambda_0) = N_{Ra}(R) \frac{d\sigma_{Ra}}{d\Omega}(\pi, \lambda_0)$$

where N_{Ra} is the number density of air molecules for Rayleigh scattering or the number density of N_2 or O_2 for Raman scattering.

$d\sigma_{Ra}/d\Omega(\pi, \lambda_0)$ is the molecular differential cross section for the Rayleigh or Raman scattering process at the laser wavelength

- From above two equations, we have

$$\alpha(R, \lambda_0) + \alpha(R, \lambda_{Ra}) = \frac{d}{dR} \ln \frac{N_{Ra}(R)}{S(R, \lambda_{Ra})} + \frac{d}{dR} \ln O(R, \lambda_{Ra})$$

where $S(R, \lambda_{Ra})$ is the range-corrected molecular signal: $S(R, \lambda_{Ra}) = P(R, \lambda_{Ra}) R^2$

- In the optimum case $O(R) \equiv 1$, i.e., good overlap

$$\alpha_{aer}(R, \lambda_0) + \alpha_{aer}(R, \lambda_{Ra}) = \frac{d}{dR} \ln \frac{N_{Ra}(R)}{S(R, \lambda_{Ra})} - \alpha_{mol}(R, \lambda_0) - \alpha_{mol}(R, \lambda_{Ra})$$

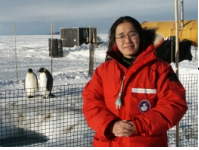

Derive Extinction from Raman/HSRL

□ To obtain the extinction coefficient at the transmitted wavelength λ_0 , we have to introduce the Angstrom exponent $\mathring{a}(R)$, which describes the wavelength dependence of the particle extinction coefficient.

$$\frac{\alpha_{aer}(\lambda_0)}{\alpha_{aer}(\lambda_{Ra})} = \left(\frac{\lambda_{Ra}}{\lambda_0} \right)^{a(R)}$$

□ Thus, the final solution of aerosol extinction is given by

$$\alpha_{aer}(R, \lambda_0) = \frac{\frac{d}{dR} \ln \frac{N_{Ra}(R)}{S(R, \lambda_{Ra})} - \alpha_{mol}(R, \lambda_0) - \alpha_{mol}(R, \lambda_{Ra})}{1 + \left(\frac{\lambda_0}{\lambda_{Ra}} \right)^{a(R)}}$$

□ For HSRL, the denominator of the above equation is 2, because $\lambda_0 = \lambda_{Ra}$

□ Angstrom exponent $\mathring{a}(R)$ ranges from 0-1.45 for 350-800 nm.

Overestimation and underestimation of the \mathring{a} value by 0.5 leads to relative errors on the order of 5%.

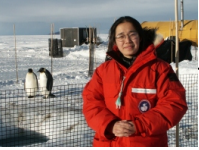

Derive Backscatter from Raman/HSRL

□ Aerosol backscatter coefficient can be calculated from the ratio of the total backscatter signal (aerosol + molecule) to the molecular backscatter signal as below.

$$\beta_{aer}(R, \lambda_0) + \beta_{mol}(R, \lambda_0) = \left[\beta_{aer}(R_0, \lambda_0) + \beta_{mol}(R_0, \lambda_0) \right] \frac{P(R_0, \lambda_{Ra}) P(R, \lambda_0)}{P(R_0, \lambda_0) P(R, \lambda_{Ra})} \frac{N_{Ra}(R)}{N_{Ra}(R_0)}$$

$$\times \frac{\exp\left\{-\int_{R_0}^R [\alpha_{aer}(r, \lambda_{Ra}) + \alpha_{mol}(r, \lambda_{Ra})] dr\right\}}{\exp\left\{-\int_{R_0}^R [\alpha_{aer}(r, \lambda_0) + \alpha_{mol}(r, \lambda_0)] dr\right\}}$$

Here, R_0 is a reference point, which is usually chosen in upper troposphere or lower stratosphere so that it is free of aerosols and the molecular backscatter coefficient can be reliably estimated from atmos conditions.

□ The aerosol lidar ratio is then given by

$$L_{aer}(R, \lambda_0) = \frac{\alpha_{aer}(R, \lambda_0)}{\beta_{aer}(R, \lambda_0)}$$

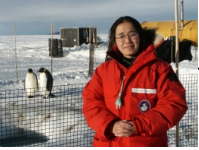

Properties of Aerosols in Atmosphere

Table 4.1. Properties of aerosol types [1]^a

Aerosol type	N (cm^{-3})	r_{eff} (μm)	ssa ($0.55 \mu\text{m}$)	g ($0.55 \mu\text{m}$)	\tilde{a} ($0.35\text{--}0.55 \mu\text{m}$)	\tilde{a} ($0.55\text{--}0.8 \mu\text{m}$)
Cont. clean	2600	0.247	0.972	0.709	1.10	1.42
Cont. average	15,300	0.204	0.925	0.703	1.11	1.42
Cont. polluted	50,000	0.150	0.892	0.698	1.13	1.45
Urban	158,000	0.139	0.817	0.689	1.14	0.43
Desert	2300	1.488	0.888	0.729	0.20	0.17
Marit. clean	1520	0.445	0.997	0.772	0.12	0.08
Marit. polluted	9000	0.252	0.975	0.756	0.41	0.35
Marit. tropical	600	0.479	0.998	0.774	0.07	0.04
Arctic	6600	0.120	0.887	0.721	0.85	0.89
Antarctic	43	0.260	1.000	0.784	0.34	0.73
Stratosphere (12–35 km)	3	0.243	1.000	0.784	0.74	1.14

^aNumber concentration is denoted by N . The effective radius r_{eff} describes the mean size of the particle ensemble. The single-scattering albedo ssa is defined as the ratio of total scattering to extinction of the investigated particle ensemble. The asymmetry parameter g is a measure of light scattered toward the forward direction compared with the light scattered toward the back direction. The Ångström exponent \tilde{a} [2] describes the spectral slope of the optical coefficients. All numbers hold for a relative humidity of 80%. Effective radius is calculated for 50% relative humidity. A further discussion of some of the parameters is given in Section 4.3.

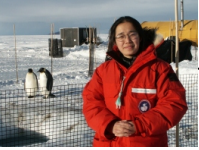

Comparison of Single & Multi-Channel Lidar

❑ Single-channel elastic scattering lidar: Klett method in deriving aerosol extinction, i.e., assuming the lidar ratio for aerosol (extinction coefficient to backscatter coefficient ratio). This is an unreliable method as this ratio can vary from 20 to 100 sr.

$$L_{aer}(R) = \frac{\alpha_{aer}(R)}{\beta_{aer}(R)}$$

❑ Multi-channel elastic (HSRL) or inelastic (Raman) lidar: providing more spectral information to derive aerosol characteristics more precisely. In this method, the Angstrom exponent that describes the wavelength dependence of the aerosol extinction coefficient has to be assumed. However, the aerosol results are insensitive to the Angstrom component value (unlike the lidar ratio).

$$\frac{\alpha_{aer}(\lambda_0)}{\alpha_{aer}(\lambda_{Ra})} = \left(\frac{\lambda_{Ra}}{\lambda_0} \right)^{a(R)}$$

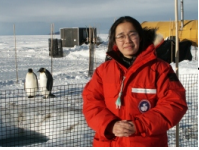

High Spectral Resolution Lidar with Scanning Fabry-Perot Interferometer

- ❑ The idea is to use a frequency-stabilized laser and a scanning Fabry-Perot interferometer to infer the combined particulate and molecular spectrum. This technique was pioneered by Fiocco et al. [1971].
- ❑ The broadband molecular component of the measured spectrum can be fitted to predictions of a model molecular spectrum. The backscatter ratio can then be determined from the atmospheric density at the measurement altitude and the ratio of the areas under aerosol and molecular scattering curves.
- ❑ Disadvantages of scanning FPI (according to Dr. Edwin E. Eloranta)
 - (1) FPI filter is narrow so rejects most of the molecular scattering signals
⇒ low system efficiency and long measurement time.
 - (2) Spectral components are measured sequentially, allowing temporal variations of the atmospheric conditions to distort the spectrum.



HSRL with Fixed Fabry-Perot Etalon

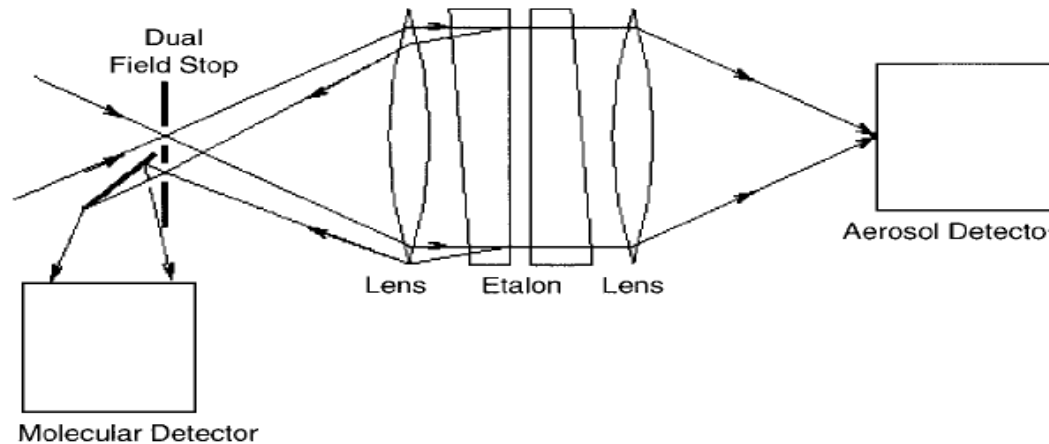

- ❑ System efficiency can be improved with non-scanning FPI. The FPI (etalon) is locked to the laser wavelength. Two detectors are employed: one for signal passing the FPI, and another for signal reflected from the FPI.
- ❑ Most of the aerosol scattering passes through the etalon transmission band with only a small fraction reflected. The Doppler-broadened molecular scattering is reflected outside the etalon transmission band and divided more equally between two channels.
- ❑ If the spectral transmission and reflection characteristics of the etalon are known, a model of the molecular spectrum can be used with an independently supplied atmospheric temperature profile to predict the transmission of the two channels for both aerosol and molecular signals. \Rightarrow for separating aerosol from molecular signals to derive aerosol information more precisely.



Fixed FPI Advantages and Disadvantages

□ Advantages:

- (1) Errors due to temporal variations in the scattering media are suppressed because both signals are measured simultaneously.
- (2) System efficiency is improved because the filter bandwidths are larger and both transmitted and reflected signals are detected.
- (3) The etalon can be tuned to any wavelength from UV to visible to IR.

□ Disadvantages:

- (1) The high-resolution etalons are sensitive to thermal and mechanical perturbations.
- (2) At a given spectral resolution, the product of the etalon diameter and the angular acceptance of an etalon is limited. As a result, large telescopes require large and expensive etalons.



HSRL with Atomic and Molecular Absorption (Blocking) Filter

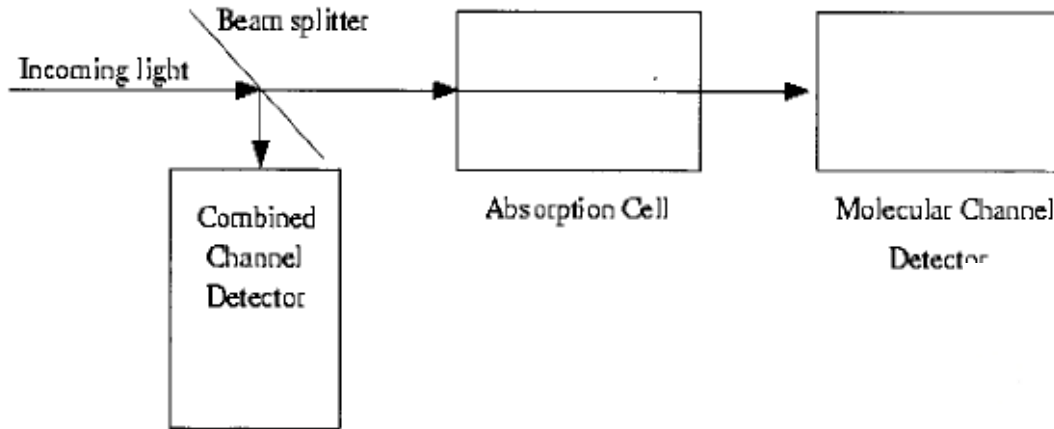

Atomic or molecular absorption block the aerosol scattering

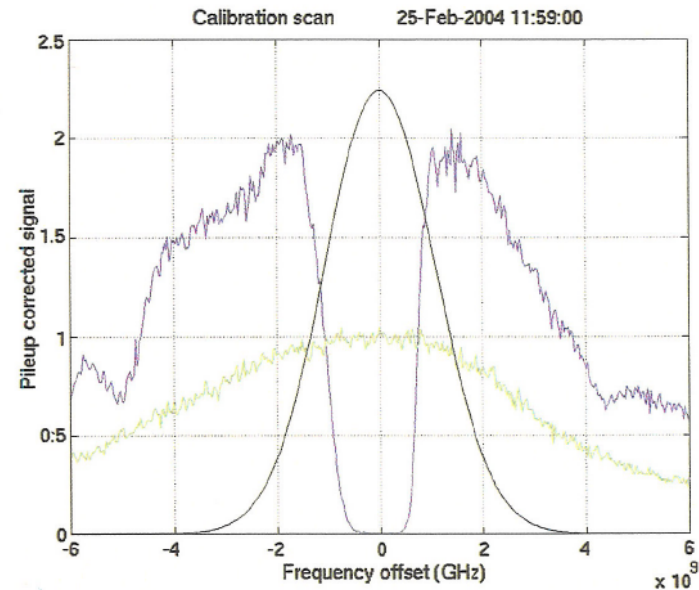
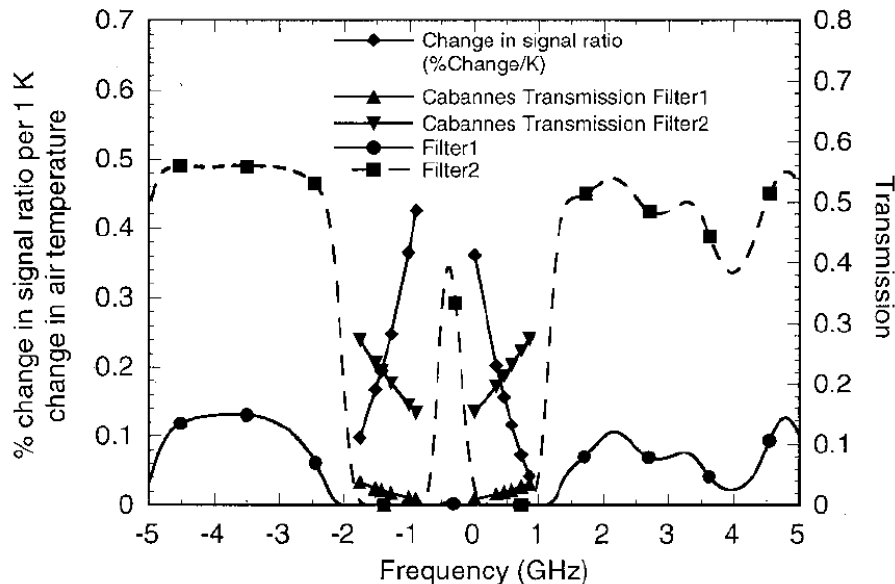
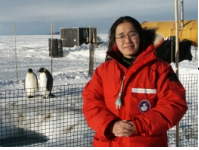

Fig. 5.5. Calibration scan showing the transmission of the molecular (blue) and combined (green) channels as a function of frequency. The Doppler broadened molecular spectrum for 300 K is also shown (black). Line 1109 of the iodine absorption spectrum (central notch) rejects most of the aerosol scattering and the central portion of the molecular scattering while passing the wings of the molecular line. The spectral transmission of the combined channel is determined by the pre-filter etalon.



Atomic and Molecular Absorption Filter: Advantages and Disadvantages

❑ Advantages:

- (1) The atomic/molecular vapor version HSRL replace the temperature-sensitive and mechanical-sensitive Fabry-Perot etalon with a robust and stable atomic/molecular absorption filter.
- (2) It also provides much larger acceptance angle, overcoming the FPI limitation.

❑ Disadvantages:

- (1) The atomic/molecular absorption filters only work at certain wavelengths, limiting the application of available lasers.
 - (2) The Ba vapor cell needs high operating temperature.
- ❑ Now (I_2) iodine-vapor-cell-based HSRL has become robust and suitable for long-term deployment.
- ❑ Other atomic vapor cell like Na, K, Ba can also work for particular wavelengths and situations.

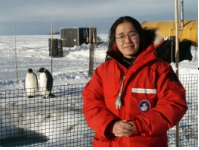

University of Wisconsin HSRL on HIAPER

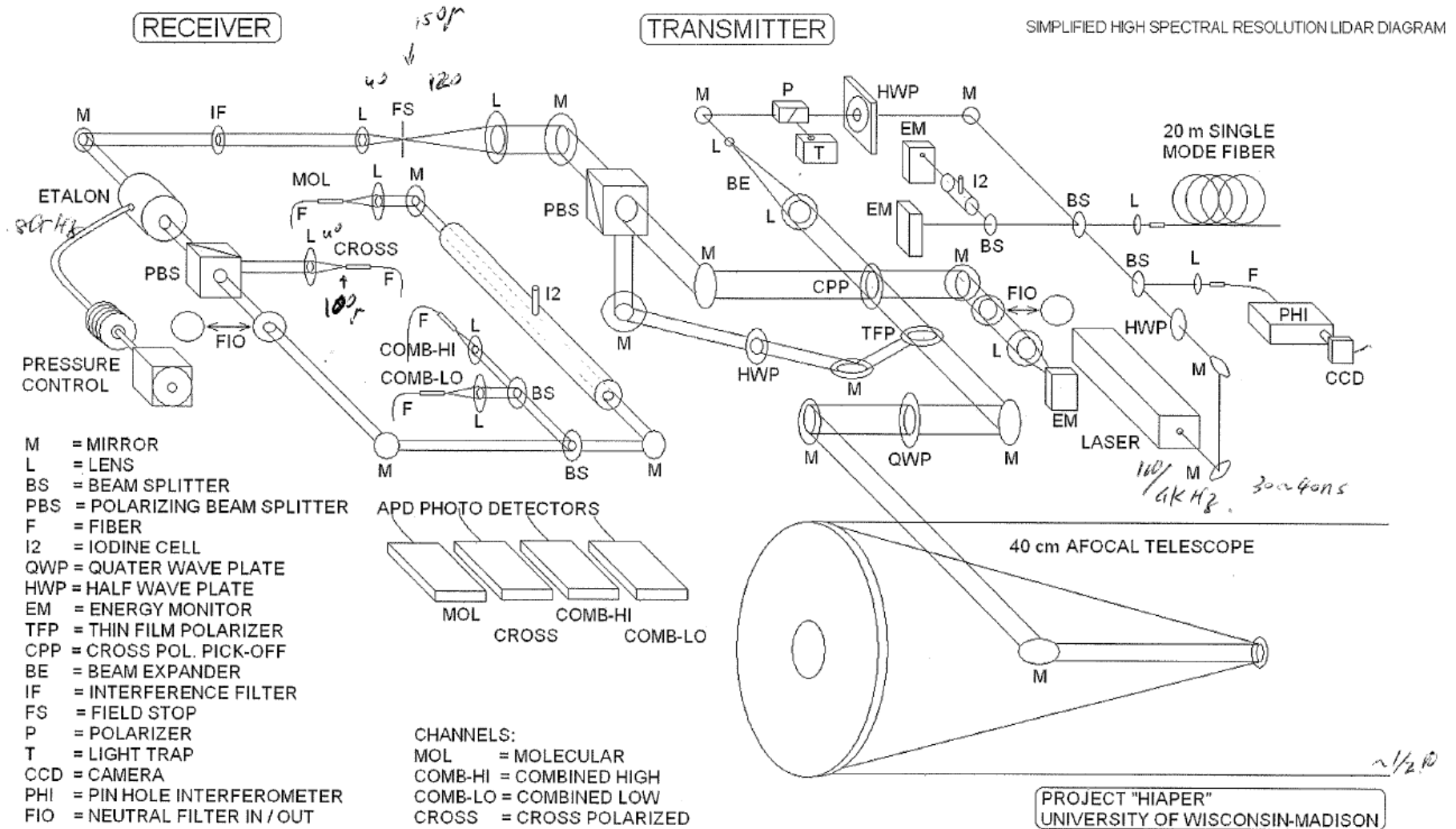

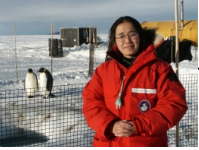

HSRL Measurement Results

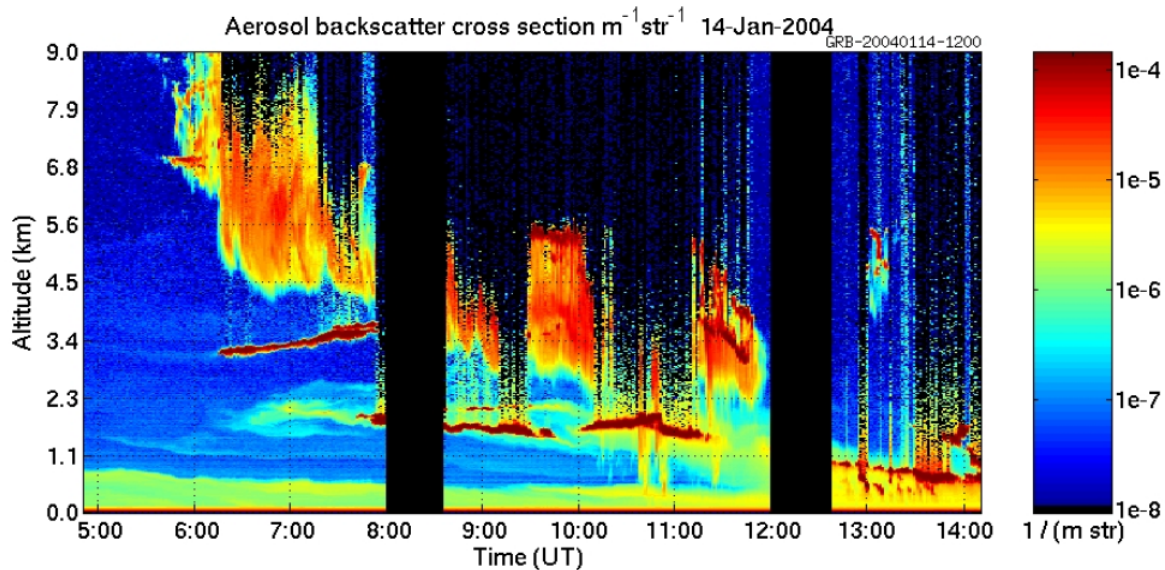

Figure 2: Calibrated backscatter cross section image derived using both HSRL data channels. This image is attenuation corrected and shadowing does not affect the measured cross section until signals are completely attenuated (black areas). Notice the greatly improved rendition of low density aerosol layers and of the upper layer of cirrus clouds.

A book chapter
 “High Spectral Resolution Lidar”
 by Dr. Edwin E. Eloranta
 University of Wisconsin

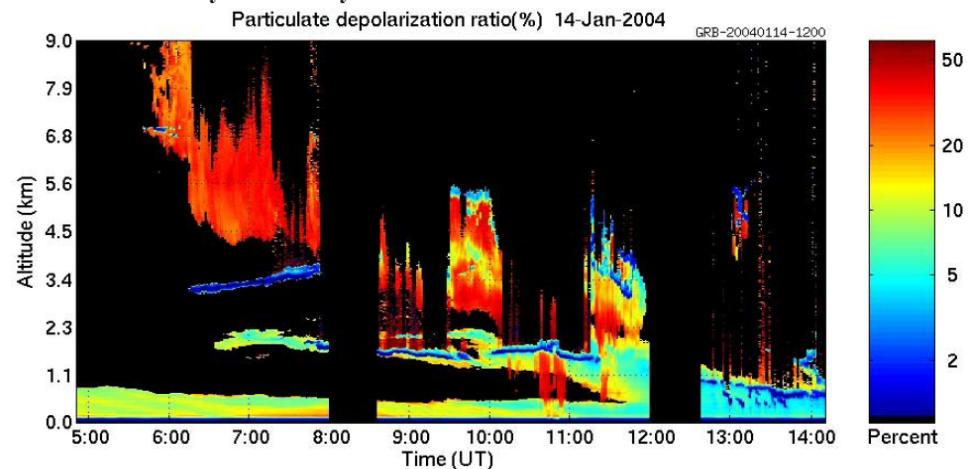
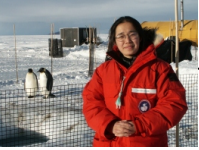
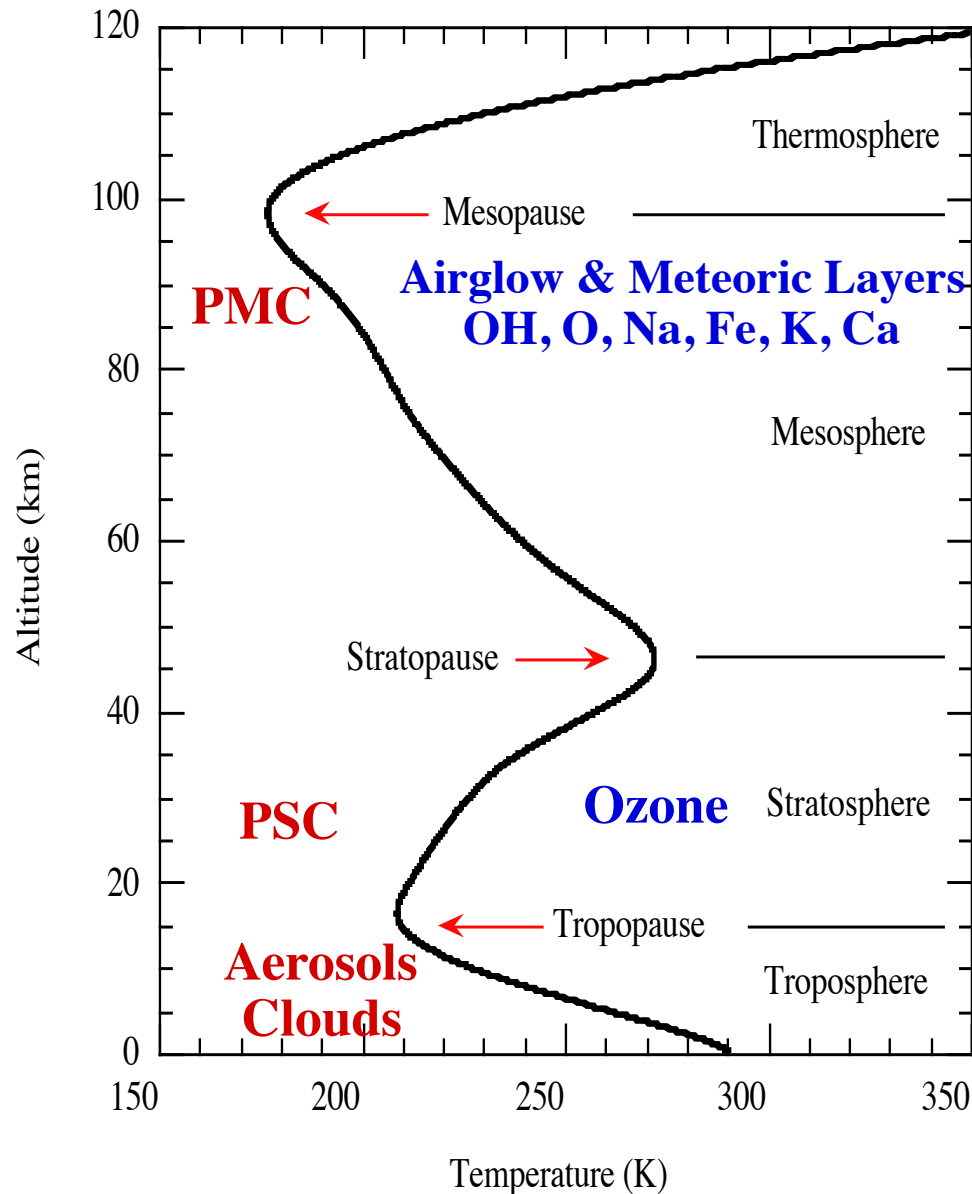

Figure 3: Circular depolarization ratio (note: log scale) for all points with particulate to molecular backscatter ratio >0.2 . Water clouds (blue) are easily distinguished from ice clouds (red).



Aerosol Lidar Technique Comparison



- ❑ Aerosols in mesosphere (Mesospheric Clouds ~ 85 km): Rayleigh/Mie lidar, resonance fluorescence lidar (detuned)
- ❑ Aerosols in upper stratosphere (Polar Stratospheric Clouds ~ 20 km): Rayleigh/Mie lidar, resonance fluorescence lidar
- ❑ Aerosols in lower stratosphere and troposphere: Rayleigh/Mie elastic-scattering lidar, Raman scattering lidar, High-Spectral-Resolution Lidar (HSRL)
- ❑ In all altitude range, polarization & multi-wavelength detections help reveal aerosol microphysical properties

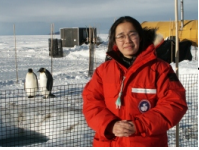

Summary

- ❑ Aerosol is an important topic in atmospheric science and environmental research. It can be measured/monitored by hot lidar technologies.
- ❑ Single-channel elastic-scattering lidar can beautifully detect PMC and PSC backscatter, and monitor the occurrence, height, vertical structure, etc. However, it is unreliable to derive aerosol extinction.
- ❑ Multi-channel lidars like Raman lidar and HSRL provide addition information by adding Raman channel or separating molecular scattering from aerosol scattering. Both can measure aerosol backscatter and extinction nicely. HSRL is more desirable when longer range detection is needed as Rayleigh scattering is much stronger than Raman scattering.
- ❑ Precise aerosol measurements require good spectrum measurements to distinguish aerosol from molecular signals. High spectral resolution lidar, especially the ones based on iodine or atomic absorption filters, promises very bright future.
- ❑ Multi-wavelength and polarization detection can help identify aerosol shape, size, distribution, and number density.
- ❑ Aerosol study is growing, and awaiting for more smart lidar ideas.