

Lecture 30. Lidar Error and Sensitivity Analysis

- Introduction
- Accuracy versus Precision
- Accuracy in lidar measurements
- Precision in lidar measurements
- Propagation of errors vs. differential method
- Sensitivity analysis
- Summary

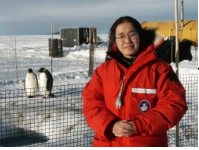

Introduction

❑ Before going further, let us rule out one kind of errors – **illegitimate errors** that originate from mistakes in measurement or computation.

❑ Have you heard about the measurement of “faster-than-light neutrinos”, announced in September 2011?

-- It is totally due to a bad error in the experiments: wrong measurement of time of flight! The experiments were also badly designed – using GPS instead of atomic clock to count the time!

<http://news.sciencemag.org/scienceinsider/2012/02/breaking-news-error-undoes-faster.html>

<http://www.bbc.co.uk/news/science-environment-17560379>

❑ A good reference book for general error analysis is “Data Reduction and Error Analysis for the Physical Sciences” by Philip R. Bevington and D. Keith Robinson (3rd edition, 2003).

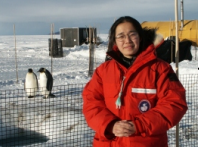

Accuracy versus Precision

- ❑ It is important to distinguish between the terms accuracy and precision, because in error analysis, accuracy and precision are two different concepts, describing different aspects of a measurement.
- ❑ The accuracy of an experiment is a measure of how close the result of the experiment is to the true value.
- ❑ The precision is a measure of how well the result has been determined, without reference to its agreement with the true value. The precision is also a measure of the reproducibility of the result in a given experiment.
- ❑ Accuracy concerns about bias, i.e., how far away is the measurement result from the true value? Precision concerns about uncertainty, i.e., how certain or how sure are we about the measurement result?
- ❑ For any measurement, the results are commonly expected to be a mean value with a confidence range: $x_i \pm \Delta x_i$

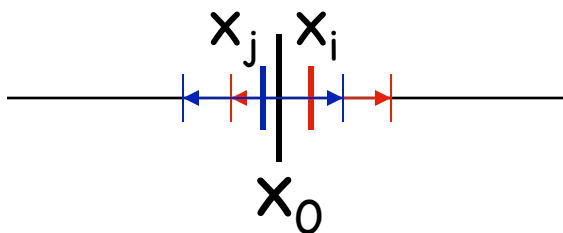

Accurate, but
Not Precise

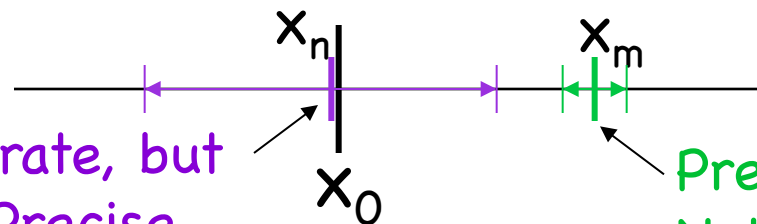

Precise, but
Not Accurate 3

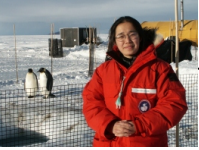

Illustration of Accuracy and Precision

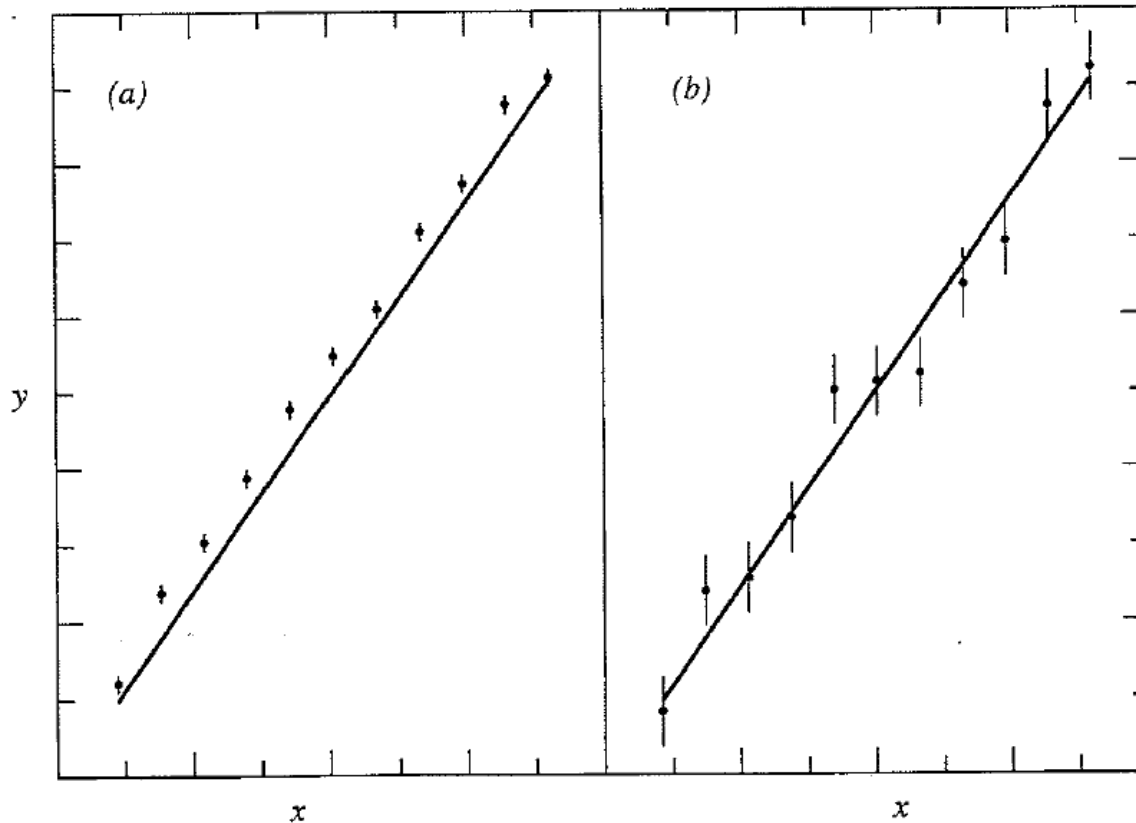
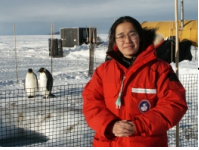

FIGURE 1.1

Illustration of the difference between precision and accuracy. (a) Precise but inaccurate data. (b) Accurate but imprecise data. True values are represented by the straight lines.



Classification of Measurement Errors

- ❑ Measurement errors are classified into two major categories: Systematic errors and random errors.
- ❑ Systematic errors are errors that will make our results different from the “true” values with reproducible discrepancies. Errors of this type are not easy to detect and not easily studied by statistical analysis. They must be estimated from an analysis of the experimental conditions, techniques, and our understanding of physical interactions. A major part of the planning of an experiment should be devoted to understanding and reducing sources of systematic errors.
- ❑ Random errors are fluctuations in observations that yield different results each time the experiment is repeated, and thus require repeated experimentation to yield precise results.
- ❑ Another way to describe systematic and random errors are: Experimental uncertainties that can be revealed by repeating the measurements are called random errors; those that cannot be revealed in this way are called systematic errors.

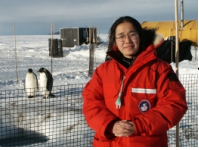
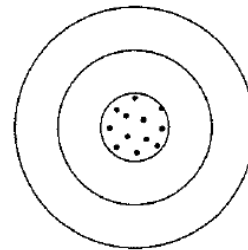
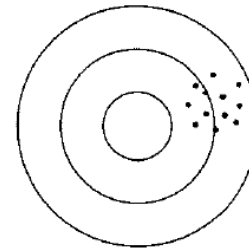

Illustration of Accuracy and Precision



Random: small
Systematic: small

(a)



Random: small
Systematic: large

(b)

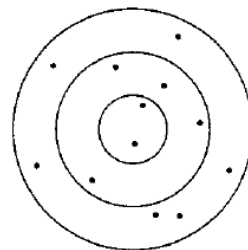

Random: large
Systematic: small

(c)

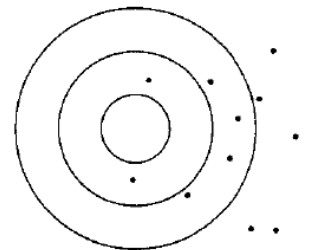

Random: large
Systematic: large

(d)

Figure 4.1. Random and systematic errors in target practice. (a) Because all shots arrived close to one another, we can tell the random errors are small. Because the distribution of shots is centered on the center of the target, the systematic errors are also small. (b) The random errors are still small, but the systematic ones are much larger—the shots are “systematically” off-center toward the right. (c) Here, the random errors are large, but the systematic ones are small—the shots are widely scattered but not systematically off-center. (d) Here, both random and systematic errors are large.

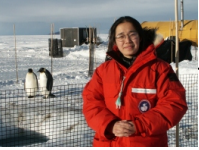
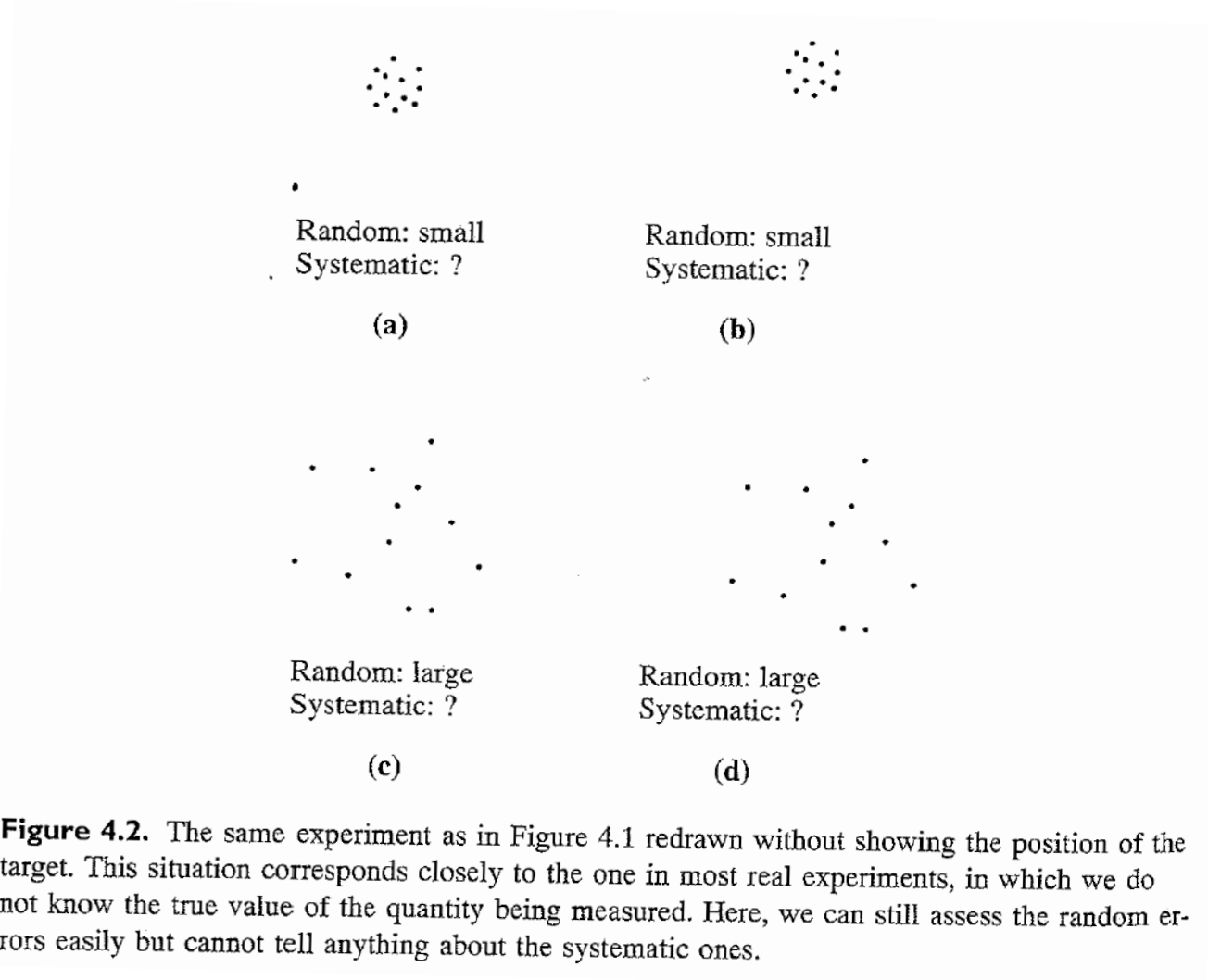
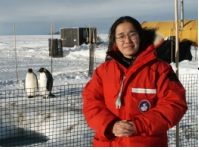

Illustration of Accuracy and Precision





Errors vs. Accuracy & Precision

- ❑ The accuracy of an experiment is generally dependent on how well we can control or compensate for systematic errors. How well the assumptions made are close to reality will affect accuracy.
- ❑ The precision of an experiment depends upon how well we can overcome random errors.
- ❑ A given accuracy implies an equivalent precision and, therefore, also depends on random errors to some extent.

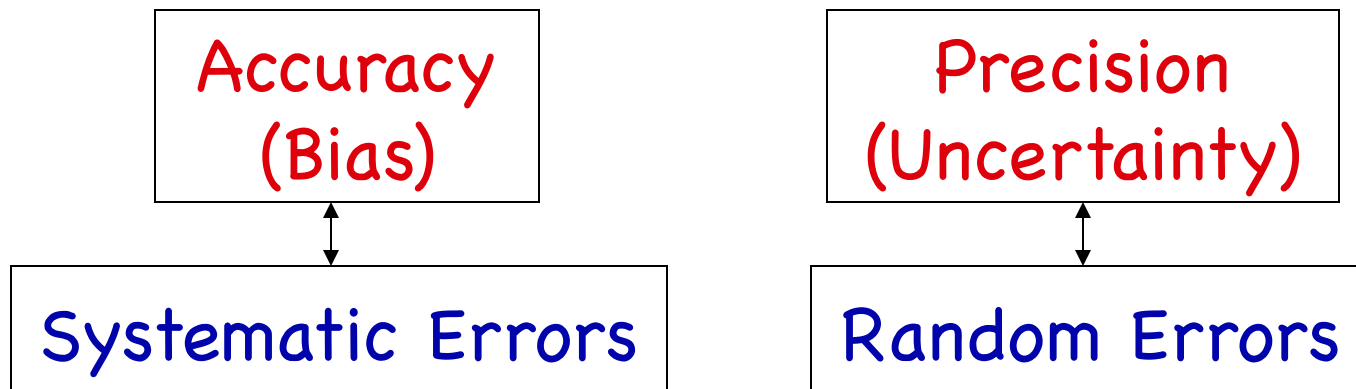

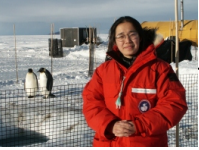

Accuracy in Lidar Measurements

- ❑ Systematic errors determine the measurement accuracy. Assumptions made in data retrieval can also contribute to inaccuracy.
- ❑ Accuracy is mainly determined by: (1) How much we understand the physical interactions and processes involved in the measurements or observations, e.g., atomic parameters and absorption cross-section, isotopes, branching ratio, Hanle effect, atomic layer saturation effect, transmission/extinction, interference absorption, etc. (2) How well we know the lidar system parameters, e.g., laser central frequency, laser linewidth and lineshape, photo detector/discriminator calibration, receiver filter function, overlapping function, chopper function, etc.
- ❑ It happened in the history of physical experiments (e.g., quantum frequency standard) that when people understood more about the physical processes or interactions, the claimed experimental accuracy decreased. This is because some systematic errors (bias) caused by certain interactions were not included in earlier error analysis, as people were not aware of them. This could also happen to lidar measurements.
- ❑ In the following lectures on different types of lidars, keep in mind such a question: What affects the lidar measurement accuracy?

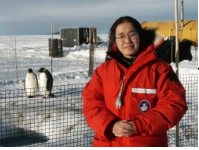

Example: Fe Boltzmann Lidar

- Systematic bias of temperature measurements can be caused by ignoring the branching ratio in the Fe Boltzmann lidar.

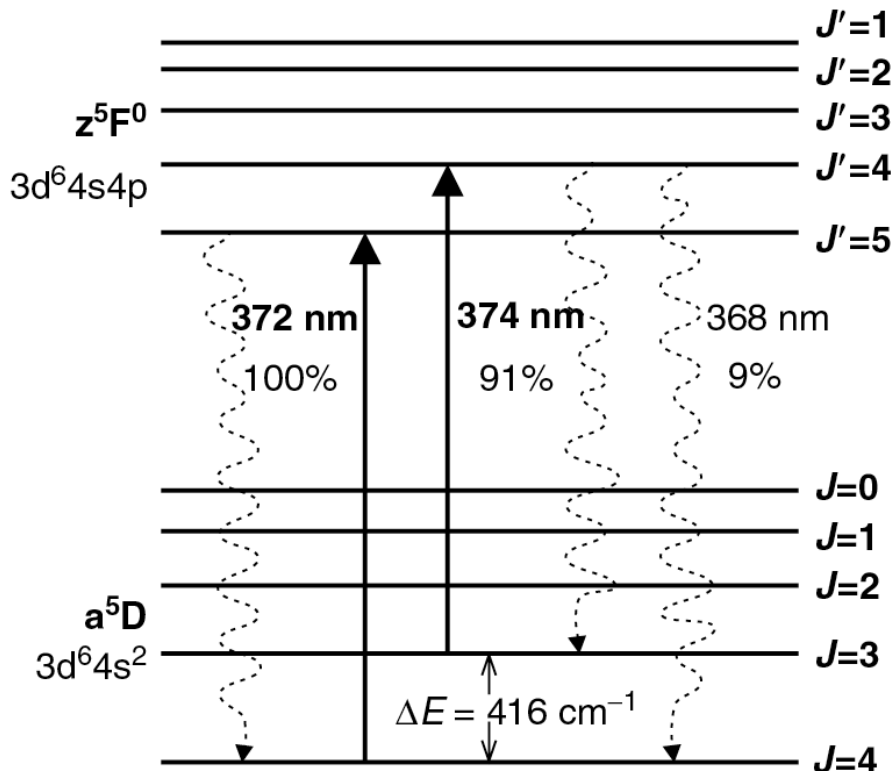

Atomic Fe Energy Level

[Gelbwachs, 1994; Chu et al., 2002]

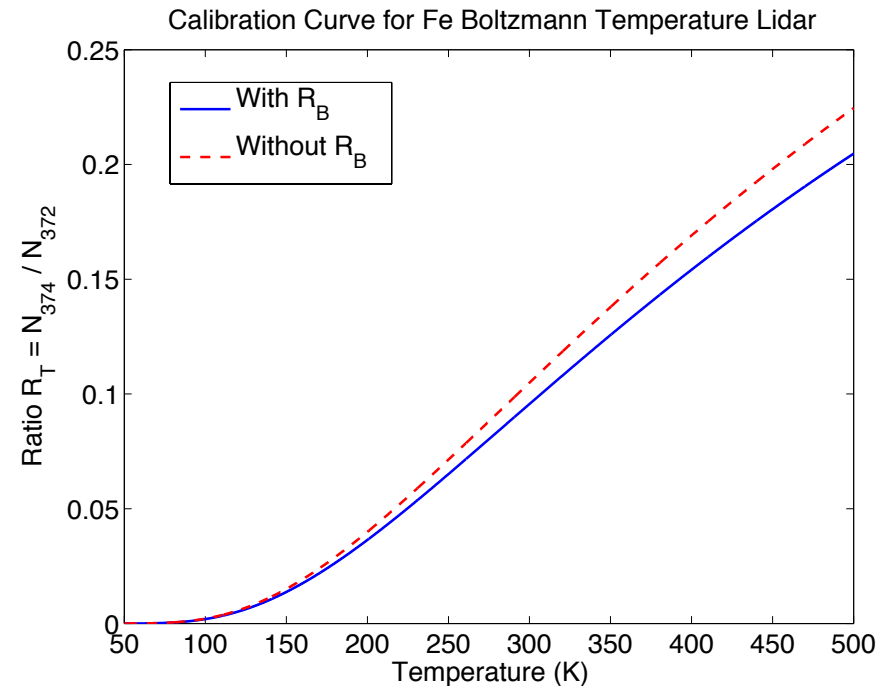

Calibration curve for Fe Boltzmann lidar

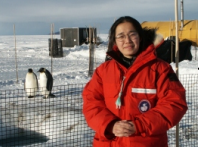

Fe Boltzmann Temperature Ratio

□ Fe resonance fluorescence lidar equation

$$N_{Fe}(\lambda, z) = \left(\frac{P_L(\lambda)\Delta t}{hc/\lambda} \right) \left[\sigma_{eff}(\lambda, \sigma_L, T, \nu_R) R_{B\lambda} n_{Fe}(z) \right] \Delta z \left(\frac{A}{4\pi z^2} \right) \left(T_a^2(\lambda) T_c^2(\lambda, z) \right) (\eta(\lambda) G(z)) \quad (10.1)$$

Rayleigh scattering lidar equation at Rayleigh-normalization altitude z_R

$$N_R(\lambda, z_R) = \left(\frac{P_L(\lambda)\Delta t}{hc/\lambda} \right) \left[\sigma_R(\pi, \lambda) n_R(z_R) \right] \Delta z \left(\frac{A}{z_R^2} \right) T_a^2(\lambda, z_R) (\eta(\lambda) G(z_R)) \quad (10.2)$$

Rayleigh normalization leads to normalized photon counts

$$N_{Norm}(\lambda, z) = \frac{N_{Fe}(\lambda, z)}{N_R(\lambda, z_R)} \frac{1}{T_c^2(\lambda, z)} \frac{z^2}{z_R^2} = \frac{\sigma_{eff}(\lambda, \sigma_L, T, \nu_R) R_{B\lambda} n_{Fe}(\lambda, z)}{\sigma_R(\lambda, z) n_R(\lambda, z_R)} \quad (10.3)$$

□ Take the Boltzmann temperature ratio as

$$R_T(z) = \frac{N_{norm}(\lambda_{374}, z)}{N_{norm}(\lambda_{372}, z)} = \frac{g_2}{g_1} \frac{R_{B374}}{R_{B372}} \left(\frac{\lambda_{374}}{\lambda_{372}} \right)^{4.0117} \frac{\sigma_{eff}(\lambda_{374}, \sigma_{L374}, T, \nu_R)}{\sigma_{eff}(\lambda_{372}, \sigma_{L372}, T, \nu_R)} \exp(-\Delta E / k_B T) \quad (10.4)$$

□ Therefore, temperature can be derived as

$$T(z) = \frac{\Delta E / k_B}{\ln \left[\frac{g_2}{g_1} \frac{R_{B374}}{R_{B372}} \left(\frac{\lambda_{374}}{\lambda_{372}} \right)^{4.0117} \frac{\sigma_{eff}(\lambda_{374}, \sigma_{L374}, T, \nu_R)}{\sigma_{eff}(\lambda_{372}, \sigma_{L372}, T, \nu_R)} \frac{1}{R_T(z)} \right]} \quad (10.5)$$

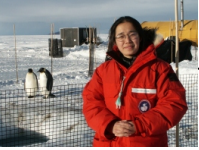

Accuracy in Lidar Measurements

- ❑ In the DIAL, if some interference gases were unknown to people thus were not considered or compensated in data reduction, bias could be resulted.
- ❑ In Rayleigh integration lidars, the major issues affecting accuracy would be the photo detector/discriminator calibration (saturation), overlapping, chopper, and filter functions, interference from aerosol scattering, and atmosphere constant change in the upper atmosphere when air is NOT well mixed.
- ❑ In Raman lidars, how well we know the Raman scattering cross-section, filter function (determine how many Raman lines are detected), aerosol interference, etc would affect the accuracy.
- ❑ In high-spectral resolution lidar, how well we know the spectral analyzer and how stable the spectral analyzer is, will affect the accuracy and long-term stability.
- ❑ If we do not know our lidar parameters well, bias could also be resulted, e.g., the chirp issue in Na, K, or Fe Doppler lidar due to pulsed amplification. If we were not aware of PMT and discriminator saturation issue, systematic bias could result from our ignorance. If we couldn't measure the narrowband filter function well for daytime observations, systematic errors would occur.
- ❑ For horizontal wind measurements, how accurate we know the off-zenith angle and the azimuth angle would also affect our measurement accuracy.

Possible Errors or Biases

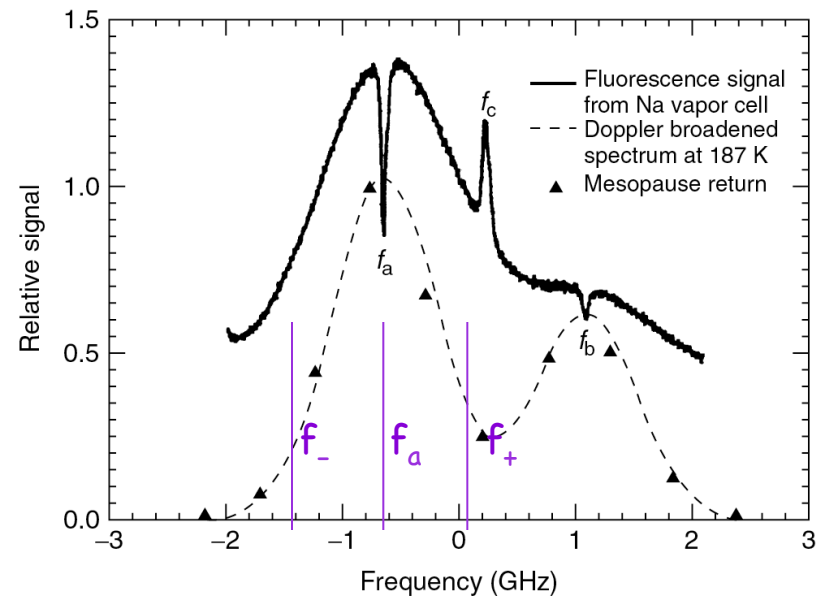
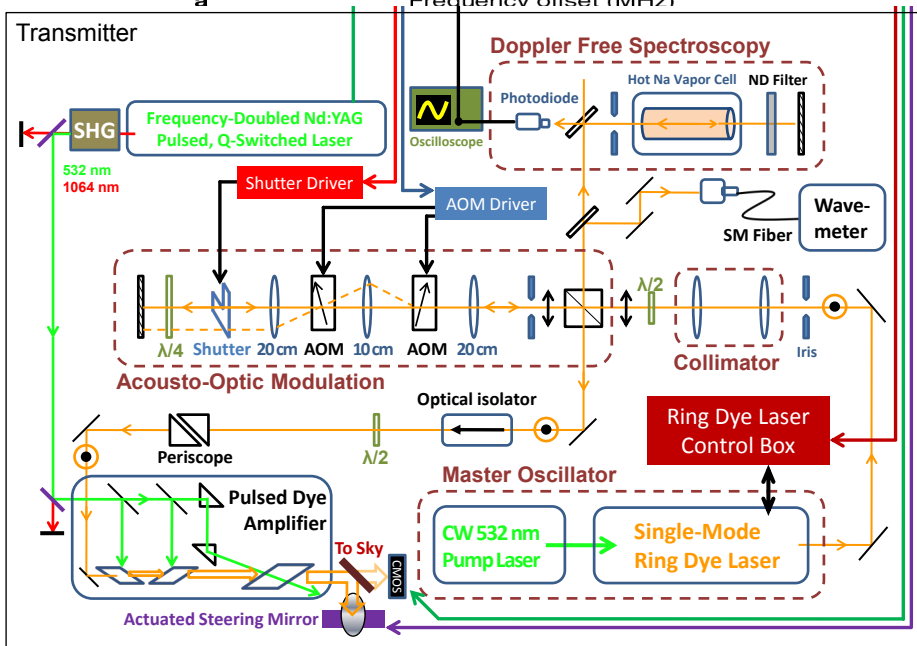
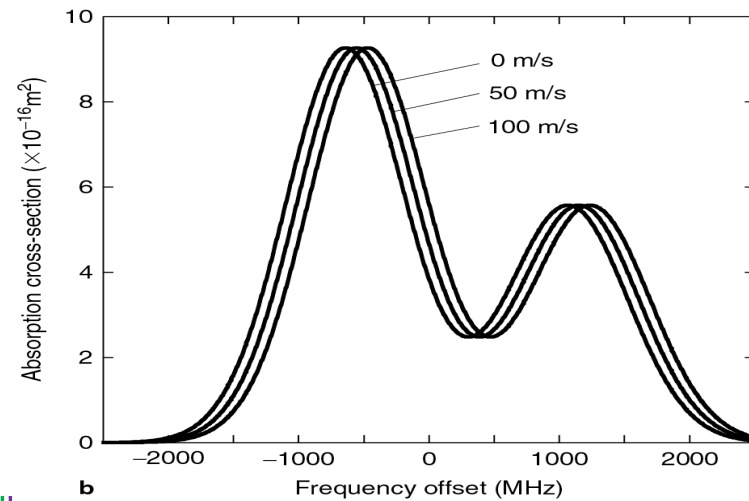
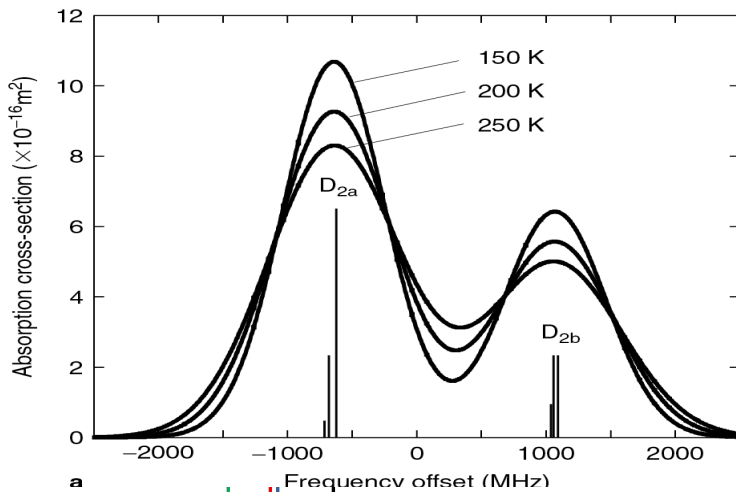

1) Laser freq locking error, 2) pulsed laser freq chirp, 3) laser line shape and linewidth, 4) Hanle effect, 5) metal layer saturation, etc. ...

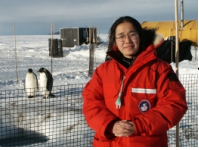

Error Analysis: Accuracy

- ❑ Systematic errors determine the measurement accuracy.
- ❑ Possible sources: imprecise information of (1) atomic absorption cross-section, (2) laser absolute frequency calibration, (3) laser lineshape, (4) receiver filter function, (5) photo detector calibration, (6) geometric factor, (7) interference gases and aerosols, (8) pressure broadening ...
- ❑ Determination of $\sigma_{\text{abs}}(\nu)$: QM calculation, convolution of Gaussian with Lorentzian, Hanle effect, Na layer saturation, and optical pumping effect.

Hanle effect modified A_n :

5, 5, 2, 14, 5, 1 \rightarrow

5, 5.48, 2, 15.64, 5, 0.98

- ❑ Absolute laser frequency calibration and laser lineshape.
- ❑ Receiver filter function and geometric factor.
- ❑ Photon detector and discriminator calibration

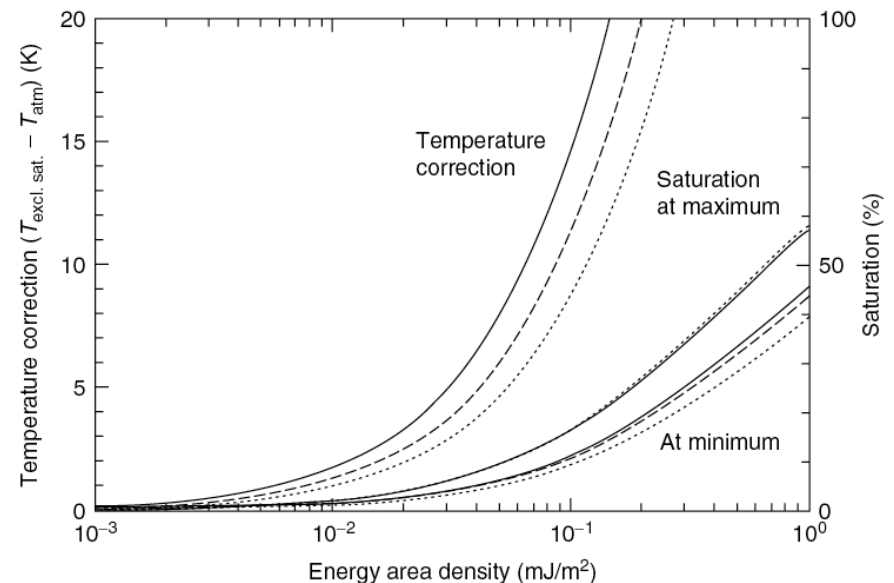

Na Layer Saturation

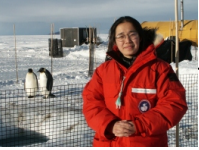

Accuracy in Lidar Measurements

- ❑ For lidar researchers, one of our major tasks is to understand the physical processes as good as possible (e.g., measuring atomic parameters accurately from lab experiments, seeking and understanding all possible physical interactions involved in the scattering or absorption and fluorescence processes like saturation effects, understanding the details of laser and detection process) and improve our experimental conditions to either avoid or compensate for the systematic errors.
- ❑ These usually demand experimenters to be highly knowledgeable of atomic, molecular, and laser physics and spectroscopy, measurement procedure, etc. That's why we emphasize the spectroscopy knowledge is more fundamental to lidar technology advancement, rather than optical/laser engineering.
- ❑ Achieving high accuracy also requires experimenters to control and measure the lidar parameters very accurately and precisely. -- Easy to say but difficult to do. Calibrating your measurement tools is also very important.
- ❑ On the lidar design aspect, it would be good to develop lidar systems that are stable and less subject to laser frequency drift or chirp, etc.
- ❑ Also, sometimes it is necessary to take the trade-off between accuracy and precision, depending on the experimental purposes/goals.

Laser Lineshape and Frequency Chirp

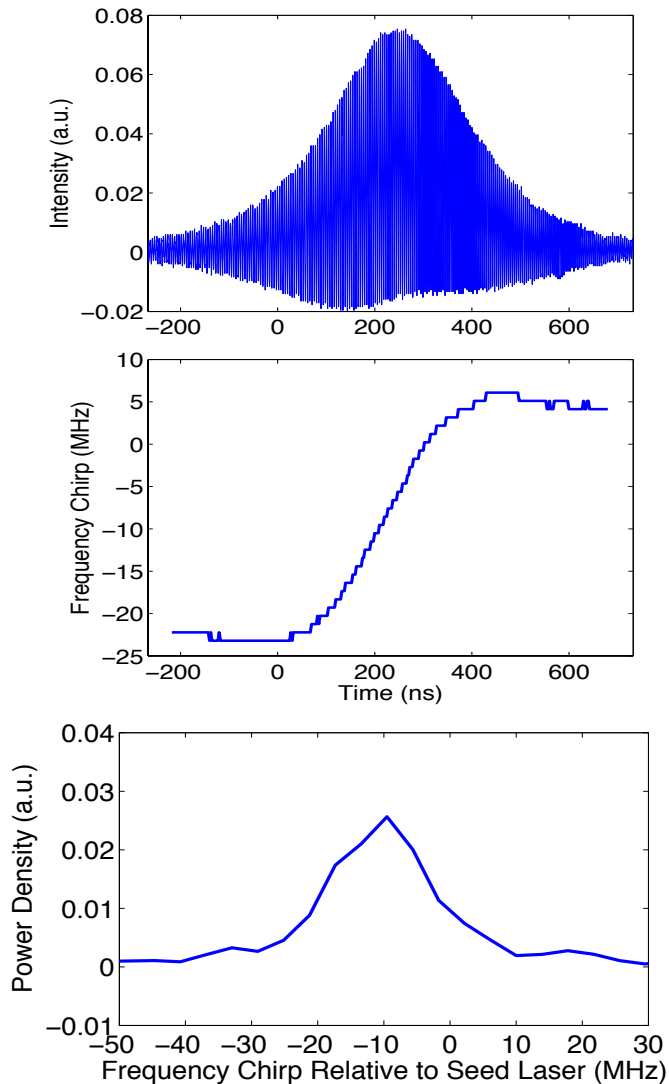
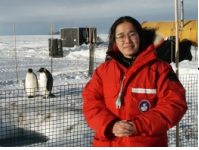

[Chu et al., ILRC, 2010]

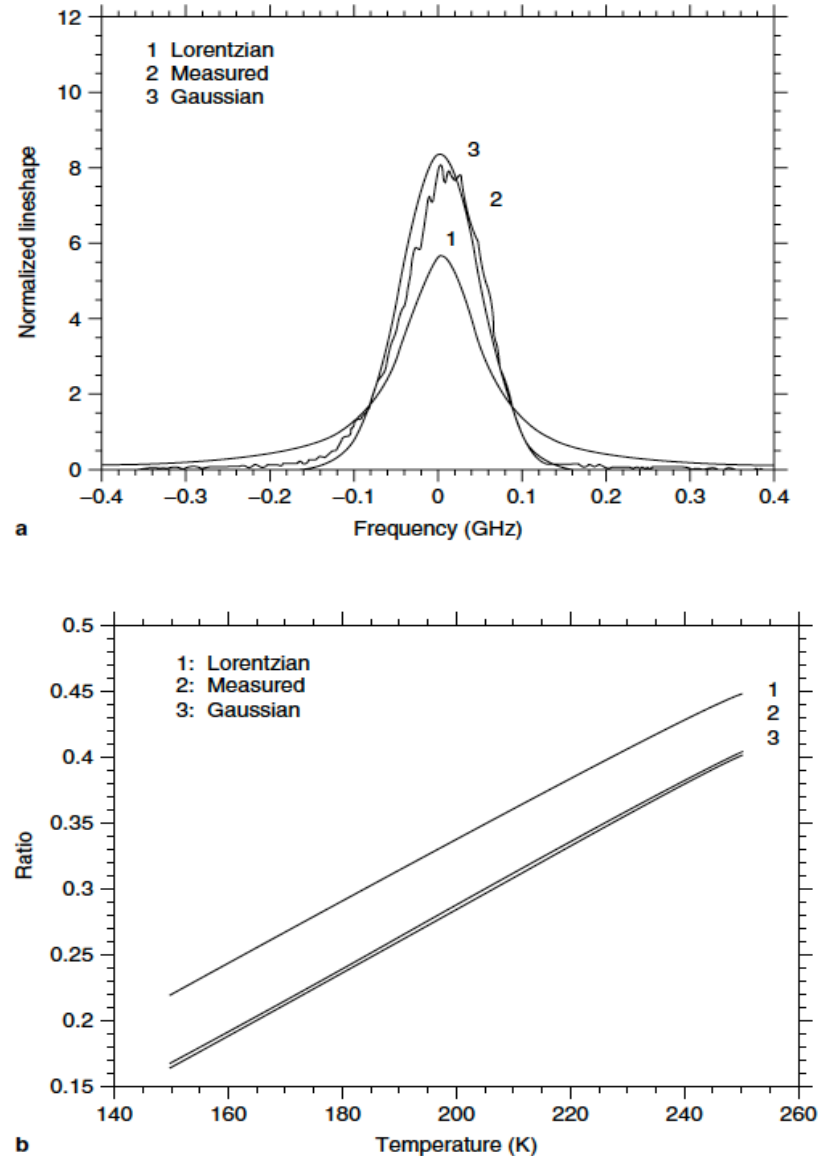

[She et al., Appl. Opt., 1992]

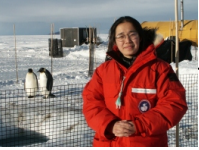

Accuracy in Lidar Measurements

- ❑ Absolute temperature and wind values are the most difficult quantities to measure in lidar field, while relative perturbations are much easier to determine.
- ❑ In lidar observations of atmosphere, the situation is more complicated as the atmosphere also experiences large geophysical variability. The geophysical variability can sometimes cover the accuracy problems of lidar measurements, and also makes the estimation of accuracy very difficult to perform.
- ❑ Inter-instrument comparison (i.e., comparison between different lidars or between lidars and other instruments in common volume and simultaneous measurements) may be necessary in the assessment of lidar measurement accuracy. However, currently most people do not pay attention to the accuracy assessment, probably due to lack of knowledge or lack of funding and time.
- ❑ For students taking this class, you should be at least aware of these issues and keep them in mind when you design and/or use a lidar system or lidar data.
- ❑ Old words say “People with less knowledge are more confident” or “Compound ignorance”. But I would rather have that you are less confident about the results with more knowledge and awareness of accuracy issues.
- ❑ Of course, the ultimate goal is to enhance our knowledge to improve accuracy or compensate systematic errors so that we are both very knowledgeable and confident in our measurement results.

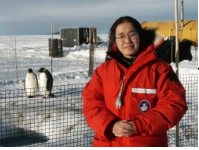

Error Analysis: Precision

- ❑ Random errors determine the measurement precision.
- ❑ Possible sources: (1) shot noise associated with photon-counting system, (2) random uncertainty associated with laser jitter and electronic jitter. The former ultimately limits the precision because of the statistic nature of photon-detection processes.
- ❑ In normal lidar photon counting, photon counts obey Poisson distribution. Therefore, for a given photon count N , the corresponding uncertainty is

$$\Delta N = \sqrt{N}$$
- ❑ For three-frequency technique, the relative errors of R_T and R_W introduced by photon noise are (see later slides for derivation)

$$\frac{\Delta R_T}{R_T} = \frac{\left(1 + \frac{1}{R_T}\right)^{1/2}}{\left(N_{f_a}\right)^{1/2}} \left[1 + \frac{B}{N_{f_a}} \frac{\left(1 + \frac{2}{R_T^2}\right)}{\left(1 + \frac{1}{R_T}\right)} \right]^{1/2}$$

$$\frac{\Delta R_W}{R_W} = \frac{\left(1 + \frac{1}{R_W}\right)^{1/2}}{\left(N_{f_a}\right)^{1/2}} \left[1 + \frac{B}{N_{f_a}} \frac{\left(1 + \frac{1}{R_W^2}\right)}{\left(1 + \frac{1}{R_W}\right)} \right]^{1/2}$$

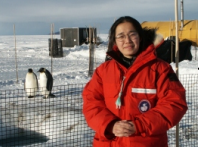

Precision in Lidar Measurements

- ❑ Precision is usually concerned with the random errors - errors that can be reduced by more repeated measurements or errors that can be reduced by sacrificing temporal or spatial resolutions.
- ❑ By making many times of the same measurements and then taking the mean of all measurements, the random errors of the measurements can be reduced. For example, when we measure the radiative lifetime of an atom through measuring the decay time, one measurement will certainly have some uncertainty. By repeating the measurements several times under the same experimental conditions, we can reduce the uncertainty.
- ❑ In lidar detection of atmosphere, we may not really repeat the “same” measurements as atmospheric conditions may never repeat. But we certainly can make more measurements under similar conditions. The accumulation of more lidar shots is equivalent to repeating the same measurements to reduce uncertainties caused by photon noise, laser frequency jitter, and linewidth fluctuation.

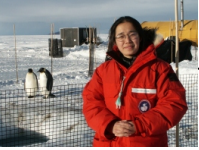

Precision in Lidar Measurements

- ❑ Photon noise is the major limitation to measurement precision. From the error equation, we know the larger the signal photon counts, the smaller the error caused by photon noise. Why so?
- ❑ A single shot results in a photon count of N with fluctuation of ΔN , leading to an error of $\Delta N/N$. When many (m) shots are integrated together, we have the photon counts roughly mN with fluctuation of $\Delta(mN)$, leading to the error of $\Delta(mN)/mN$. This error should have been reduced if we regard this integration procedure as taking a mean of repeated measurements.

$$\frac{\Delta(mN)}{mN} = \frac{\sqrt{mN}}{mN} = \frac{1}{\sqrt{m}} \cdot \frac{\sqrt{N}}{N} = \frac{1}{\sqrt{m}} \cdot \frac{\Delta N}{N}$$

- ❑ Therefore, the precision error caused by photon noise can be improved by two ways: (1) sacrifice of temporal resolution by integrating more shots together; (2) sacrifice of spatial resolution by integrating more range bins together; or the combination of both.

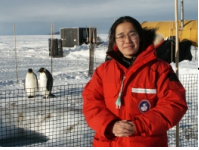

Precision in Lidar Measurements

- ❑ The precision errors caused by the random error sources like laser frequency jitter, linewidth fluctuation, and electronic jitter can be improved by integrating more shots together - sacrifice of temporal resolution, but may not be improved by integrating bins.
- ❑ Random error sources could lead to both random and systematic measurement errors. For example, laser central frequency jitter in the 3-freq ratio technique can lead to warm temperature bias (systematic error) in addition to random errors.
- ❑ This differentiation of metric ratio method described in later slides can apply to both systematic and random errors, depending on the nature of the errors. Error sources could be systematic bias or random jitter, and measurement errors could also be systematic or random errors.
- ❑ For example, the chirp in f_a is a systematic error source if it is not counted, while the jitter in f_a is a random error.

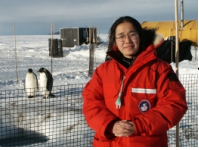

Error Analysis in Lidar Simulation

- ❑ Add this part to your lidar simulation code: usually we deal with the uncertainties caused by photon noise.
- ❑ $\partial R_T / \partial T$ can be calculated numerically for different operating points.
- ❑ Derive the $\Delta R_T / R_T$ terms by yourself, considering background, Rayleigh normalization, etc.

Error Analysis in Data Analysis

- ❑ Add this part to your data retrieval code: keep one set of photon counts for error analysis. This set of photon counts should not have PMT, chopper, and range corrections.
- ❑ In principle, we should use different operating point for each temperature/wind condition. But for general purpose of error analysis, people sometimes use a nominal point, e.g., $T = 200$ K and $V = 0$ m/s.

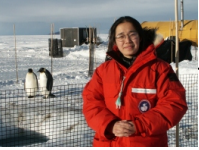

Propagation of Errors

- ❑ Propagation of Errors is an important aspect in lidar error analysis. This is because the temperature, wind, backscatter coefficient, etc. that we want to determine are dependent variables that are a function of one or more different measured variables (e.g., photon counts, laser frequency and linewidth). We must know how to propagate or carry over the uncertainties in the measured variables to determine the uncertainty in the dependent variables.
- ❑ For example, photon noise causes the uncertainty in the measured photon counts, then the photon count uncertainty leads to the uncertainty in the temperature and wind ratios R_T and R_W , which will result in errors in the inferred temperature T and wind W . -- Error propagation procedure
- ❑ Basic rules for propagation of error can be found in many textbooks, e.g., addition, subtraction, multiplication, division, product of power, and mixture of them, along with many other complicated functions.
- ❑ We will introduce a universal procedure through the use of differentials of the corresponding ratios R_T and R_W as illustrated below. This method is mathematically based on the Taylor expansion.

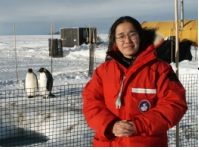

Error Analysis Procedure

□ We use the temperature error derivation for 3-freq Na lidar as an example to explain the error analysis procedure using a differentiation method.

□ For 3-frequency technique, we have the temperature ratio

$$R_T = \frac{\sigma_{eff}(f_+) + \sigma_{eff}(f_-)}{\sigma_{eff}(f_a)} = \frac{N(f_+) + N(f_-)}{N(f_a)}$$

□ Through this ratio R_T or further through the effective cross-section, the temperature T is an implicit function of R_T , laser frequencies f_a , f_+ , f_- , laser linewidth σ_L , radial wind, etc. Each parameter could have some uncertainty or error, leading to errors in the measured temperature.

□ Therefore, the temperature error is given by the derivatives

$$\Delta T = \frac{\partial T}{\partial R_T} \Delta R_T + \frac{\partial T}{\partial f_a} \Delta f_a + \frac{\partial T}{\partial f_{\pm}} \Delta f_{\pm} + \frac{\partial T}{\partial \sigma_L} \Delta \sigma_L + \frac{\partial T}{\partial v_R} \Delta v_R$$

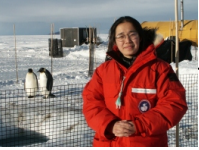

Differentiation Method

- The root-mean-square (rms) temperature error is given by

$$(\Delta T)_{rms} = \sqrt{\left(\frac{\partial T}{\partial R_T} \Delta R_T + \frac{\partial T}{\partial f_a} \Delta f_a + \frac{\partial T}{\partial f_{\pm}} \Delta f_{\pm} + \frac{\partial T}{\partial \sigma_L} \Delta \sigma_L + \frac{\partial T}{\partial v_R} \Delta v_R \right)^2}$$

- If the error sources are independent from each other, then the means of cross terms are zero. Then we have

$$(\Delta T)_{rms} = \sqrt{\left(\frac{\partial T}{\partial R_T} \Delta R_T \right)^2 + \left(\frac{\partial T}{\partial f_a} \Delta f_a \right)^2 + \left(\frac{\partial T}{\partial f_{\pm}} \Delta f_{\pm} \right)^2 + \left(\frac{\partial T}{\partial \sigma_L} \Delta \sigma_L \right)^2 + \left(\frac{\partial T}{\partial v_R} \Delta v_R \right)^2}$$

- The above error equation indicates that many laser parameters and radial wind errors could affect the inferred temperature because they all influence the effective cross sections. In the meantime, photon noise can cause uncertainty in the ratio R_T , resulting in temperature error.

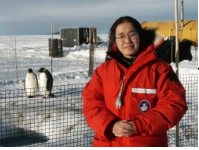

Error Derivation: Implicit Differentiation

- How to derive the error coefficients, like $\frac{\partial T}{\partial R_T}$, $\frac{\partial T}{\partial f_a}$, etc. ?
- We may use the implicit differentiation through R_T as below:

$$\Delta T = \Delta R_T \left(\frac{\partial R_T}{\partial R_T} / \frac{\partial R_T}{\partial T} \right) + \Delta f_a \left(\frac{\partial R_T}{\partial f_a} / \frac{\partial R_T}{\partial T} \right) + \Delta f_{\pm} \left(\frac{\partial R_T}{\partial f_{\pm}} / \frac{\partial R_T}{\partial T} \right) \\ + \Delta \sigma_L \left(\frac{\partial R_T}{\partial \sigma_L} / \frac{\partial R_T}{\partial T} \right) + \Delta v_R \left(\frac{\partial R_T}{\partial v_R} / \frac{\partial R_T}{\partial T} \right)$$

- For the photon-noise induced temperature error,

$$\Delta T = \frac{1}{\partial R_T / \partial T} \cdot \Delta R_T = \frac{R_T}{\partial R_T / \partial T} \cdot \frac{\Delta R_T}{R_T}$$

- The relative error of R_T can be derived in terms of measured signal and background photon counts (see later slides).

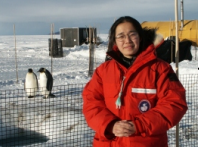

Derivation of Error Coefficients

- The temperature error coefficient can be derived numerically

$$\frac{R_T}{\partial R_T / \partial T} = \frac{R_T}{[R_T(T + \delta T) - R_T(T)] / \delta T}$$

- Two approaches to derive the above numerical solution:

- (1) One way is to use the equation of R_T in terms of cross sections. You don't have to go through the entire simulation process each time when you change the temperature, but just calculate the R_T from the effective cross section.

$$R_T = \frac{\sigma_{eff}(f_+, T) + \sigma_{eff}(f_-, T)}{\sigma_{eff}(f_a, T)}$$

- (2) Another way is to use the equation of R_T in terms of photon counts, and then go through the entire simulation procedure to re-compute R_T for each new temperature. This method is more universal than the first approach, because not all cases could have a R_T written in terms of pure physical cross sections.

$$R_T = \frac{N(f_+, T) + N(f_-, T)}{N(f_a, T)}$$

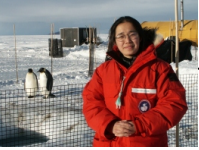

Derivation of $\Delta R_T / R_T$

□ We use 2-freq ratio technique of Na lidar as an example to derive the relative error $\Delta R_T / R_T$.

2-freq temperature ratio is defined as

$$R_T = \frac{N_{f_c}}{N_{f_a}} \quad (1)$$

Using differentiation method, we have

$$\Delta R_T = \frac{\partial R_T}{\partial N_{f_c}} \Delta N_{f_c} + \frac{\partial R_T}{\partial N_{f_a}} \Delta N_{f_a} = \frac{1}{N_{f_a}} \Delta N_{f_c} - \frac{N_{f_c}}{N_{f_a}^2} \Delta N_{f_a} \quad (2)$$

Combining Eq. (1) with Eq. (2), we have

$$\frac{\Delta R_T}{R_T} = \frac{\Delta N_{f_c}}{N_{f_c}} - \frac{\Delta N_{f_a}}{N_{f_a}} \quad (3)$$

Regarding the errors from two frequencies are uncorrelated, we have

$$\left(\frac{\Delta R_T}{R_T} \right)_{rms} = \sqrt{\left(\frac{\Delta N_{f_c}}{N_{f_c}} - \frac{\Delta N_{f_a}}{N_{f_a}} \right)^2} = \sqrt{\left(\frac{\Delta N_{f_c}}{N_{f_c}} \right)^2 + \left(\frac{\Delta N_{f_a}}{N_{f_a}} \right)^2} \quad (4)$$

Considering the signal photon counts are derived by subtracting the background counts from the total photon counts, the photon count

uncertainty is given by

$$\overline{(\Delta N_{f_c})^2} = N_{f_c} + B, \quad \overline{(\Delta N_{f_a})^2} = N_{f_a} + B \quad (5)$$

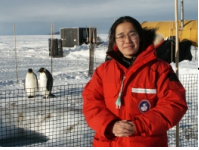

Derivation of $\Delta R_T/R_T$ Cont'd

- Substituting Eq. (5) into Eq. (4) and considering Eq. (1), we obtain

$$\left(\frac{\Delta R_T}{R_T}\right)_{rms} = \sqrt{\frac{N_{f_c} + B}{N_{f_c}^2} + \frac{N_{f_a} + B}{N_{f_a}^2}} = \sqrt{\frac{R_T N_{f_a} + B}{(R_T N_{f_a})^2} + \frac{N_{f_a} + B}{N_{f_a}^2}} \quad (6)$$

- Some algebra derivation leads us to the final result

$$\left(\frac{\Delta R_T}{R_T}\right)_{rms} = \frac{\left(1 + \frac{1}{R_T}\right)^{1/2}}{\left(N_{f_a}\right)^{1/2}} \left[1 + \frac{B}{N_{f_a}} \frac{\left(1 + \frac{1}{R_T^2}\right)}{\left(1 + \frac{1}{R_T}\right)}\right]^{1/2} \quad (7)$$

- If we change the expression to SNR of the peak frequency channel, then we have an approximate expression as below:

$$\left(\frac{\Delta R_T}{R_T}\right)_{rms} \approx \frac{1}{SNR_{f_a}} \sqrt{1 + \frac{1}{R_T}} \quad (8)$$

where SNR is defined as

$$SNR_{f_a} \equiv \frac{N_{f_a}}{\Delta N_{f_a}} = \frac{N_{f_a}}{\sqrt{N_{f_a} + B}} \quad (9)$$

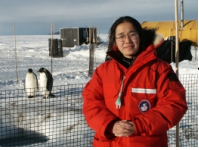

Temperature Error Due to Photon Noise

□ Integrating above equations together, we obtain the equation for the temperature error caused by photon noise as below:

$$\Delta T = \frac{R_T}{\partial R_T / \partial T} \cdot \frac{\Delta R_T}{R_T}$$

$$= \frac{R_T}{[R_T(T + \delta T) - R_T(T)] / \delta T} \cdot \frac{\left(1 + \frac{1}{R_T}\right)^{1/2}}{\left(N_{fa}\right)^{1/2}} \left[1 + \frac{B}{N_{fa}} \frac{\left(1 + \frac{2}{R_T^2}\right)}{\left(1 + \frac{1}{R_T}\right)} \right]^{1/2}$$

□ The photon counts in the above equation can be written in terms of signal to noise ratio (SNR), if it is more convenient or desirable for some analyses.

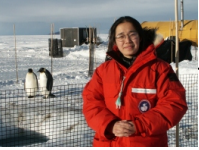

Sensitivity Analysis

- **Sensitivity Analysis** is part of a complete lidar simulation and error analysis. It is to answer the question how sensitive the measurement errors depend on lidar, atomic, and atmospheric parameters.
- We will show how several key lidar parameters affect measurement errors: (1) laser rms linewidth, and (2) laser central frequency.
- These factors are closely related to instrument design, while other factors like cross-talk between temperature and wind error, Hanle effect, etc. can be addressed independent of instrument design.
- Sensitivity Analysis helps **define the requirements on instruments**, e.g., linewidth and its stability, central frequency offset and stability, frequency shift and its stability.
- One of the main purposes for instrument design is to ensure that the accuracy or precision errors caused by lidar parameter uncertainties are less than the desired measurement errors, like 1 m/s and 1 K for wind and temperature, and also less than the errors caused by photon noise.

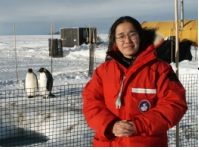

Methodology

(1) Start with the ratio metrics, like R_T or R_W , that are expressed through effective cross-section, e.g., for 3-frequency technique, as

$$R_T = \frac{\sigma_{eff}(f_+) + \sigma_{eff}(f_-)}{\sigma_{eff}(f_a)} \quad R_W = \frac{\sigma_{eff}(f_-)}{\sigma_{eff}(f_+)}$$

Thus, R_T and R_W are functions of temperature, wind, laser linewidth, laser central frequency, AOM frequency shift, and atomic parameters, etc.

$$R_T(T, V_R, \sigma_L, f_L, f_{AOM}, \dots), R_W(T, V_R, \sigma_L, f_L, f_{AOM}, \dots)$$

(2) As an example, the temperature error caused by the uncertainty in laser RMS width should be derived as

$$\Delta T = \frac{\partial T}{\partial \sigma_{rms}} \cdot \Delta \sigma_{rms} = \frac{\partial R_T / \partial \sigma_{rms}}{\partial R_T / \partial T} \cdot \Delta \sigma_{rms}$$

Based on principle of derivative of implicit function:

-- T is an implicit function of σ_{rms} through R_T .

The temperature error coefficient

is derived as

$$\frac{\partial T}{\partial \sigma_{rms}} = \frac{[R_T(\sigma_{rms} + \delta\sigma_{rms}) - R_T(\sigma_{rms})] / \delta\sigma_{rms}}{[R_T(T + \delta T) - R_T(T)] / \delta T} \quad (\text{K/MHz})$$

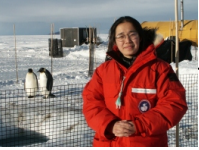

Methodology Cont' d

(3) Considering the nonlinear dependence of error coefficient on laser linewidth, actual temperature error can be calculated as (for larger uncertainty)

$$\Delta T = \frac{[R_T(\sigma_{rms} + \Delta\sigma_{rms}) - R_T(\sigma_{rms})]/\Delta\sigma_{rms}}{[R_T(T + \delta T) - R_T(T)]/\delta T} \cdot \Delta\sigma_{rms} \quad (\text{K})$$

(4) Both temperature error and error coefficient can be computed for each operating point, e.g., $T = 200$ K, $V_R = 0$ m/s, $\sigma_{rms} = 60$ MHz, etc. The operating points may be varied, e.g., try σ_{rms} of 10, 20, 30, 40, 60, 100 MHz, or $T = 150, 200, 250$ K, or $V_R = -20, 0, +20$ m/s.

(5) Such method can be applied to the wind metric R_W .

(6) Also, similar method can be used on laser central frequency, AOM frequency shift, etc. for both temperature error and wind error analyses.

➤ This differentiation approach is a method generally applicable for lidars using ratio techniques, not only Na Doppler lidar, but also Fe and K Doppler lidars, and others like edge-filter technique wind lidars, etc.

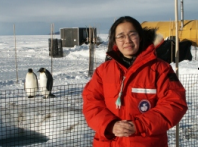

Example Results for 3-Freq Na Lidar: Laser Linewidth Influence

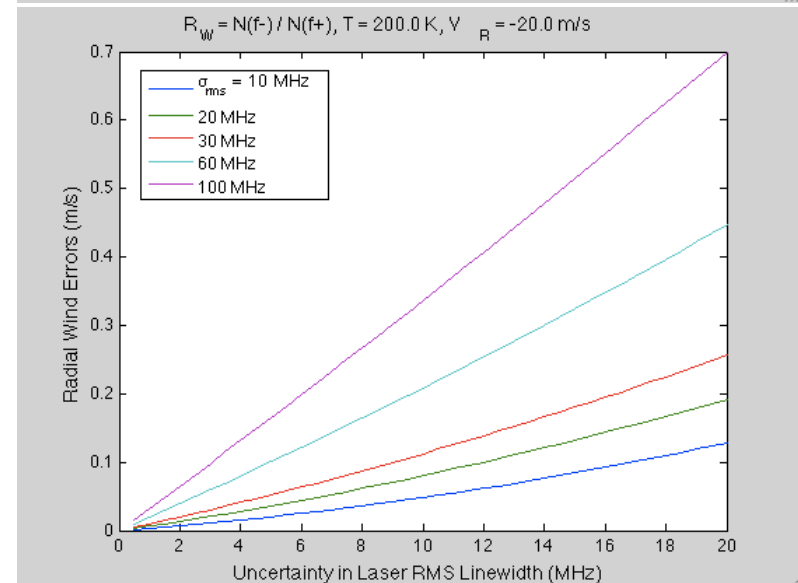
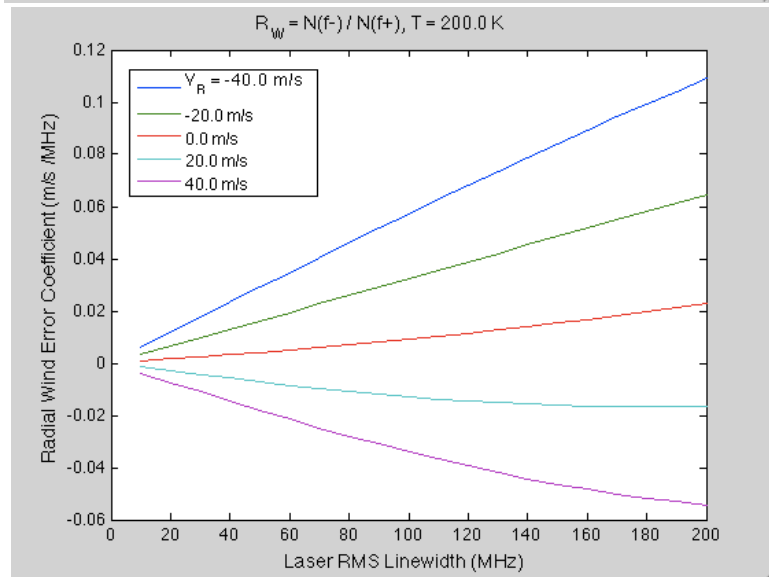
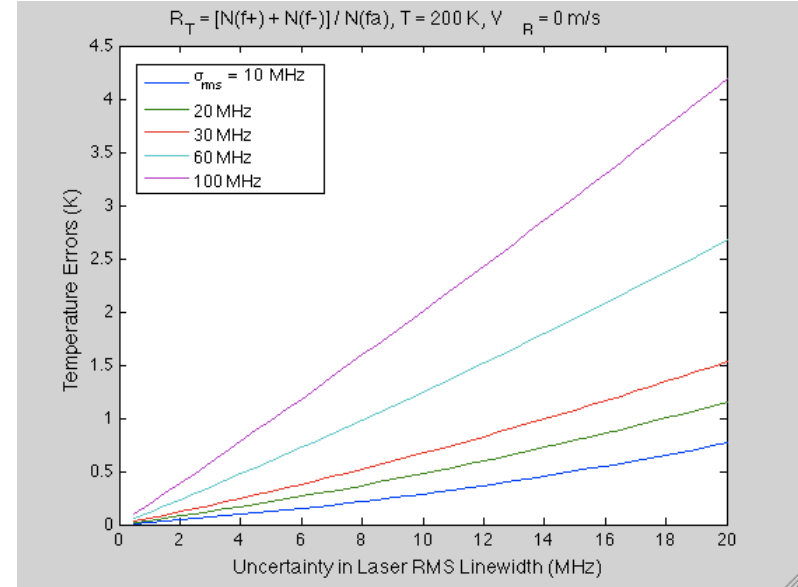
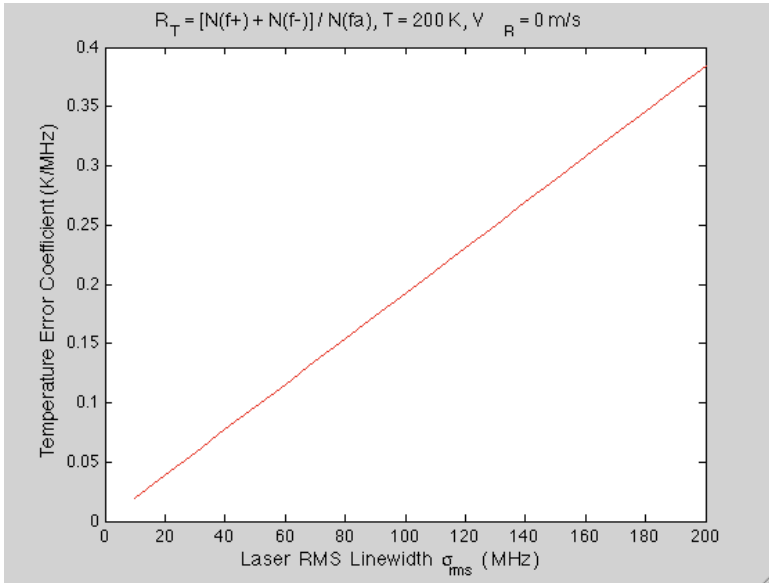

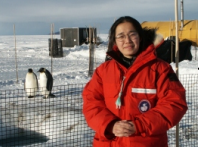

Laser Linewidth and Uncertainty

- When the laser rms linewidth (σ_{rms}) is smaller, the temperature and wind errors caused by the same uncertainty in laser linewidth are smaller.
- For 60 MHz rms linewidth (like the current dye-laser-based Na Doppler lidar), 4 MHz rms width uncertainty is acceptable.
- If the solid-state Na Doppler lidar has laser rms linewidth to about 30 MHz, then the acceptable rms width uncertainty can be larger.

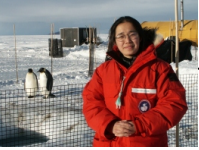

Example Results for 3-Freq Na Lidar: Laser Central Frequency

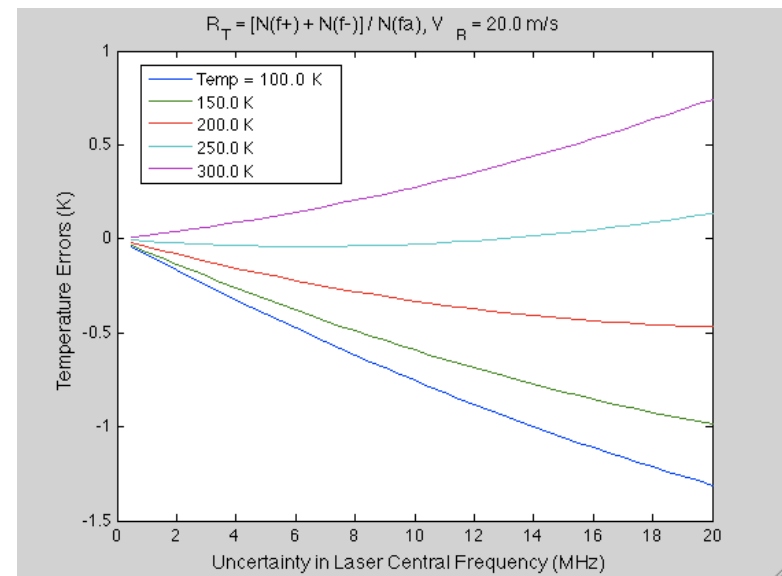
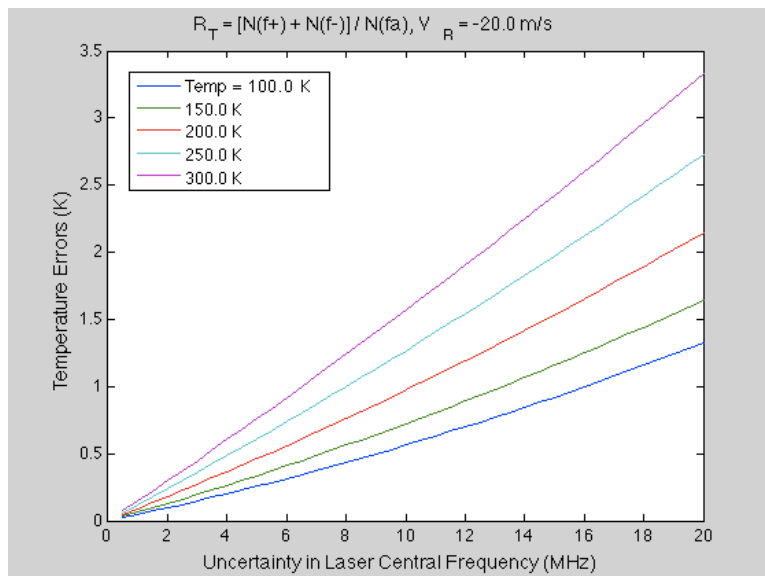
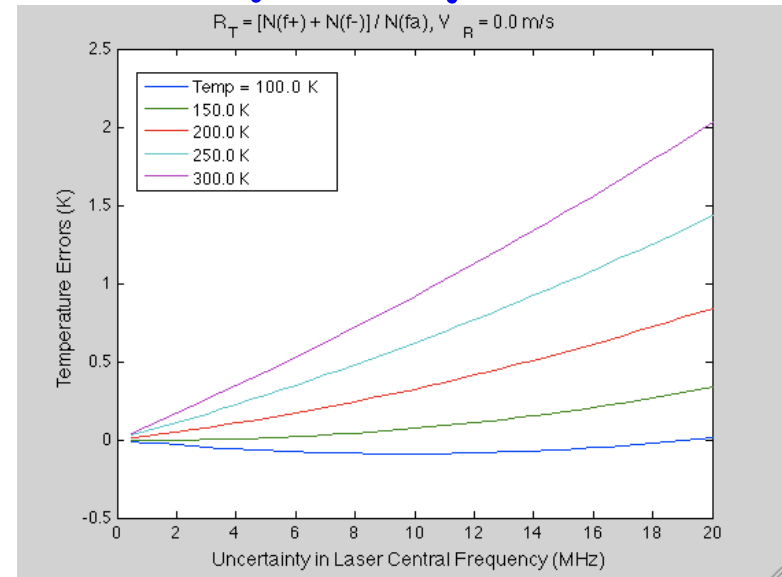
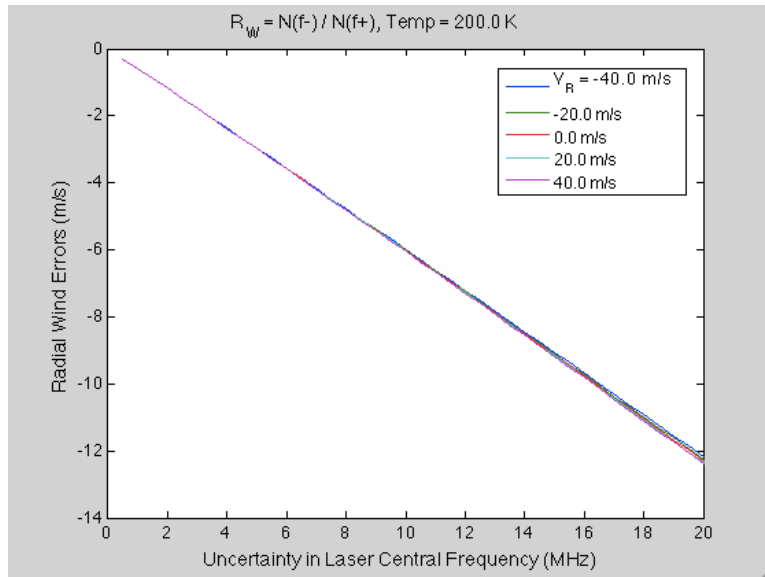

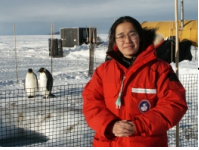

Laser Central Frequency including chirp and jitter

- Wind errors are much more sensitive to the uncertainty or bias in the laser central frequency than temperature errors.
- To keep less than 1 K temperature error, 10 MHz uncertainty or bias in laser central frequency is acceptable; however, 10 MHz would result in about 6 m/s wind error.
- To keep less than 1 m/s wind error, the uncertainty or bias in laser central frequency should be less than 2 MHz.

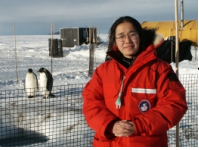

Monte Carlo Method

- ❑ To reveal how random error sources affect the measurement precision and accuracy, an approach different than the above analytical “differentiation method” is the “Monte Carlo Method”.
- ❑ It is not easy to repeat lidar observations in reality, but it is definitely achievable in lidar simulation and error analysis. The Monte Carlo method is to repeat the simulation many times with random sampling of the interested lidar or atmospheric or atomic parameters within their random error ranges and then check how the measurement results are deviated from the true values.
- ❑ For example, the laser central frequency has random errors due to frequency jitter. To investigate how it affects the measurements, we may run the simulation of single shot many times and for each shot we let the laser central frequency randomly pick one value within its jitter range. By integrating many shots together, we then look at how the temperature or wind ratios are deviated from the expected ratios if all the shots have the accurate laser frequency.

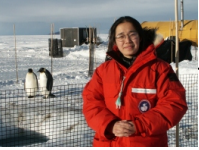

Summary

- ❑ Lidar simulation, error and sensitivity analyses are the “lidar modeling”. It is an integration of complicated lidar remote sensing procedure. Error and sensitivity analysis is an important part for lidar research. One approach is to use the “differentiation method”, and another one is the Monte Carlo approach.
- ❑ The key is still our understanding of the lidar theory and the physical interactions between the laser light and the objects you want to study. Only when we clearly understand the interactions in the atmosphere and the entire lidar detection procedure could we do good lidar simulation and error analysis.
- ❑ **Accuracy and precision** are two different concepts for lidar error analysis. Accuracy concerns about bias, usually determined by systematic errors. Precision concerns about uncertainty, mainly determined by random errors, and in lidar photon counting case, mainly by photon noise.
- ❑ The differentiation of metric ratio method can apply to both systematic and random errors, depending on the nature of the errors. Error sources could be systematic bias or random jitter, and measurement errors could also be systematic or random errors. It also works for both error analysis and sensitivity analysis.