

# Lecture 29. Constituent Lidar (1)

- ❑ Motivations to study atmosphere constituents

- ❑ Lidar detection of constituents

(essentially spectroscopic detection to distinguish species)

- ❑ Metal atoms by resonance fluorescence lidar

- ❑ DIAL detection of molecules and pollutant

(DIAL Equation, Solution, Water vapor measurement)

- ❑ Summary

# Motivations to Study Constituents

- ❑ Atmospheric constituents are referred to the trace gases that occur in relatively small but sometimes highly variable concentrations. In our class, constituents mean the atomic or molecular trace gases in the atmosphere, excluding aerosols and clouds.
- ❑ Atmospheric constituents include the metal atoms coming from meteor ablation (such as Na, Fe, K, Ca, Li, Mg, etc), the water vapor  $H_2O$ , ozone  $O_3$ , carbon dioxide  $CO_2$ , and many other molecular species coming from natural or anthropogenic sources, such as  $NO_x$ , CO, CFC,  $CH_4$ ,  $SO_2$ ,  $Cl_2$ , HCl,  $NH_3$ , etc. Some other species, like O and He in thermosphere and  $N_2^+$  occurring in aurora, are also constituents that we may consider.
- ❑ In the middle and upper atmosphere (75-120 km), the metal atoms (such as Na, Fe, K, Ca, Li, Mg, etc) are excellent trace gases so that we can measure the temperature, wind, waves, and chemistry in this region through inquiring the spectrum of the atomic resonance fluorescence.
- ❑ In thermosphere (150 km and above), the O and He atoms could provide a trace to monitor the temperature and wind in thermosphere.
- ❑  $N_2^+$  could also help us to extend into thermosphere, but only possible in polar regions when aurora occurs.
- ❑ The best technique to achieve vertical profile of the constituent density, temperature and wind is the resonance fluorescence lidar technique.

# Mesospheric Metal Atoms

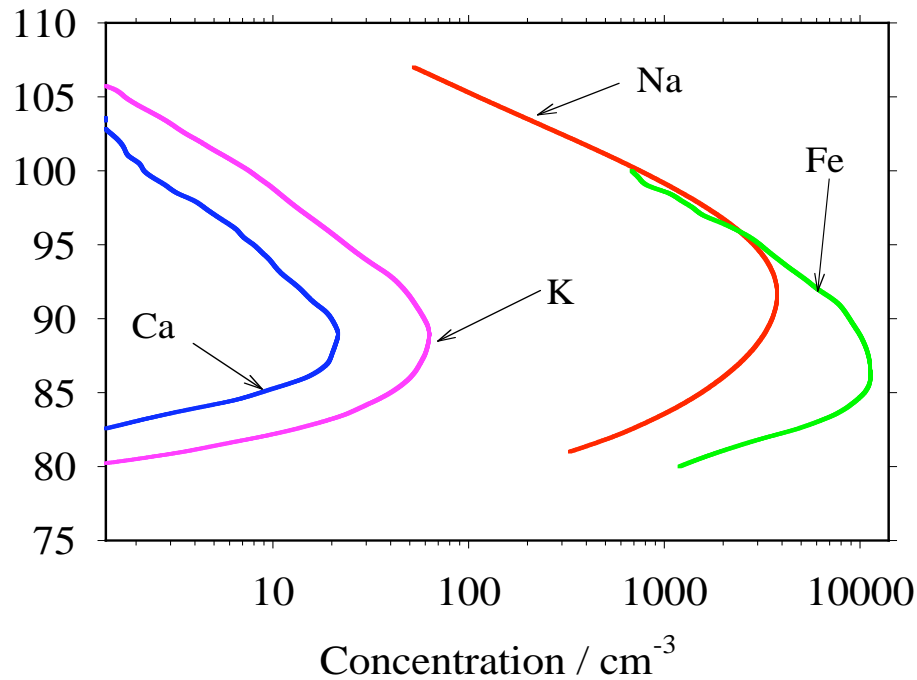

These metal atoms are believed to come from meteor ablation.

	Central Wavelength $\lambda_0$ (nm)	Atomic Mass ( $10^{-26}$ kg)	$A_{21}$ ( $10^8$ s <sup>-1</sup> )	Doppler rms width $\sigma_D$ (MHz)	Peak cross-section $\sigma_0$ ( $10^{-16}$ m <sup>2</sup> )	Oscillator strength f
K (D <sub>1</sub> )	770.1088	6.4923	0.382	267.90	13.42	0.3395
Na (D <sub>2</sub> )	589.1583	3.8177	0.616	456.54	14.87	0.6411
Ca	422.793	6.6556	2.18	481.96	38.48	1.7516
Ca <sup>+</sup>	393.777	6.6556	1.47	517.87	13.94	0.6820
Fe	372.0993	9.2738	0.163	463.79	0.944	0.0413

# Motivations Cont'd

- ❑ The importance of water vapor in the atmosphere can hardly be overestimated. Water vapor is the most important greenhouse gas, much more effective than  $\text{CO}_2$ . It governs the atmospheric water cycle which is the basis for life on earth, and it is a key component in atmospheric chemistry. The frequent occurrence of phase transitions from vapor to liquid water or ice crystals further enhances the importance of atmospheric humidity.
- ❑ Cloud formation and the various forms of precipitation certainly belong to the most important weather phenomena. The strong temperature dependence of the saturation vapor pressure in combination with vertical transport processes causes a large variability of the atmospheric humidity which exists on practically all scales from turbulence to global distribution.
- ❑ The observation capabilities for atmospheric water vapor are clearly insufficient. Most routine observations are still made using *in situ* sensors on radiosondes, either at small number of ground stations worldwide, or from aircraft, helicopters, balloons, or kites. All these have serious limitations especially for vertical profiling. Retrievals from spaceborne passive sensors (radiometer) can provide some information, but vertical resolution in particular is insufficient in view of the frequent occurrence of strong vertical gradients.
- ❑ Two lidar techniques can provide the required information on the water vapor vertical distribution with the necessary vertical and temporal resolution: Raman lidar and differential absorption lidar (DIAL).

# Motivations Cont'd

❑ Majority of the atmospheric constituents considered here are related to air pollution and global climate change. Most of them are of natural or anthropogenic origin, but CFC (chlorofluorocarbons) are only generated by human activities. CFC is responsible to ozone depletion!

❑ Some of these gases play a crucial role in the earth's radiative balance and atmospheric chemistry, e.g.,  $O_3$ . Stratospheric ozone absorbs UV sunlight, so acts as a heating source in the stratosphere and a barrier to protect life on earth from harmful UV light. Tropospheric ozone is an important greenhouse gas due to its strong IR absorption band. Ozone is the main driver of the photochemical processes and contributes to the recycling of most of the natural and anthropogenic gases. Tropospheric ozone has direct effect on human health and causes significant losses in agriculture.

❑ Two lidar techniques can provide high resolution measurements of ozone: Raman lidar and DIAL (or Raman DIAL).

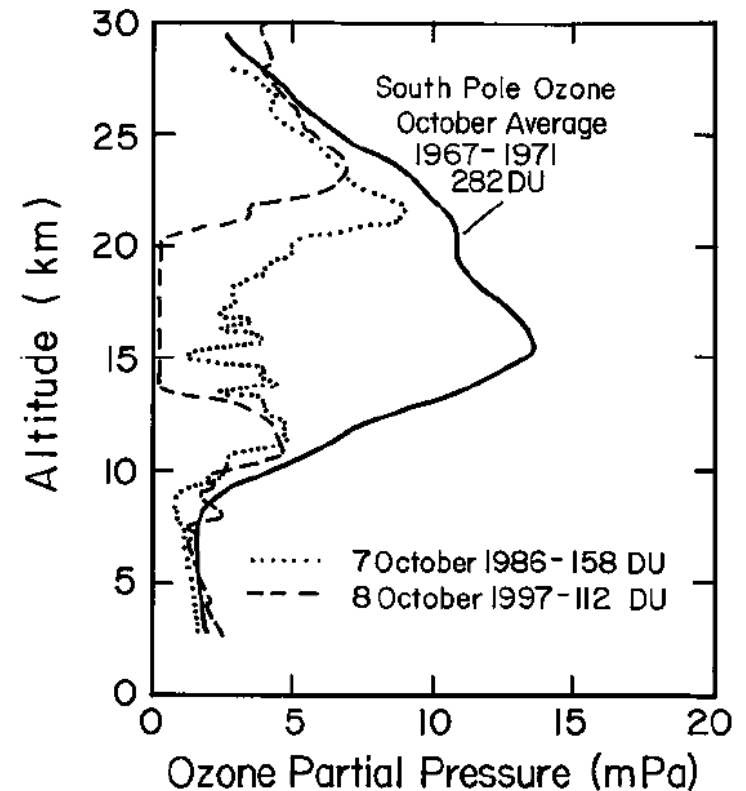

**Table 4.1** Absorption Cross Section of Pollutant Gases at Wavelengths Suitable for DIAL Measurement in the Troposphere

Molecule	Typical Wavelength	Laser (Examples)	Absorption Cross Section ( $10^{-18} \text{ cm}^2$ )
Nitric oxide, NO	226.8 nm	Dye	4.6
Benzene, C <sub>6</sub> H <sub>6</sub>	252.9 nm	Dye	5.7
Mercury, Hg	253.65 nm	Dye	$3.3 \times 10^4$
Toluene, C <sub>7</sub> H <sub>8</sub>	266.9 nm	Dye, Ti:Sa	2.8
Ozone, O <sub>3</sub>	266.0 nm	Dye, Nd:YAG-IV	9.49
	289.0 nm	Raman D <sub>2</sub>	1.59
	299.0 nm	Raman H <sub>2</sub>	0.42
Formaldehyde, CH <sub>2</sub> O	286.5 nm	Dye, Ti:Sa	0.068
Sulfur dioxide, SO <sub>2</sub>	300.0 nm	Dye, Ti:Sa	1.3
Chlorine, Cl <sub>2</sub>	330.0 nm	Dye, XeCl + Raman cell	0.26
Nitrous acid, HONO	354.0 nm	Dye, Ti:Sa	0.50
Nitrogen dioxide, NO <sub>2</sub>	448.1 nm	Dye	0.69
Methane, CH <sub>4</sub>	3.270 $\mu\text{m}$	OPO	2.0
	3.391 $\mu\text{m}$		0.6
Propane, C <sub>3</sub> H <sub>8</sub>	3.391 $\mu\text{m}$	OPO	0.8
Hydrogen chloride, HCl	3.636 $\mu\text{m}$	DF, OPO	0.20
Methane, CH <sub>4</sub>	3.715 $\mu\text{m}$	DF, OPO	0.002
Sulfur dioxide, SO <sub>2</sub>	3.984 $\mu\text{m}$	DF, OPO	0.42
Carbon monoxide, CO	4.709 $\mu\text{m}$	CO <sub>2</sub>	2.8
	4.776 $\mu\text{m}$		0.8
Nitric oxide, NO	5.215 $\mu\text{m}$	CO	0.67
	5.263 $\mu\text{m}$	CO <sub>2</sub>	0.6
Propylene, C <sub>3</sub> H <sub>6</sub>	6.069 $\mu\text{m}$	CO	0.09
1,3-Butadiene, C <sub>4</sub> H <sub>6</sub>	6.215 $\mu\text{m}$	CO	0.27
Nitrogen dioxide, NO <sub>2</sub>	6.229 $\mu\text{m}$	CO	2.68
Sulfur dioxide, SO <sub>2</sub>	9.024 $\mu\text{m}$	CO <sub>2</sub>	0.25
Freon-11, CCl <sub>3</sub> F	9.261 $\mu\text{m}$	CO <sub>2</sub>	1.09
Ozone, O <sub>3</sub>	9.505 $\mu\text{m}$	CO <sub>2</sub>	0.45
	9.508 $\mu\text{m}$		0.9
Fluorocarbon-113, C <sub>2</sub> Cl <sub>3</sub> F <sub>3</sub>	9.604 $\mu\text{m}$	CO <sub>2</sub>	0.77
Benzene, C <sub>6</sub> H <sub>6</sub>	9.621 $\mu\text{m}$	CO <sub>2</sub>	0.07
MMH, CH <sub>3</sub> N <sub>2</sub> H <sub>3</sub>	10.182 $\mu\text{m}$	CO <sub>2</sub>	0.06
Ethyl mercaptan, C <sub>2</sub> H <sub>5</sub> SH	10.208 $\mu\text{m}$	CO <sub>2</sub>	0.02
Chloroprene, C <sub>4</sub> H <sub>5</sub> Cl	10.261 $\mu\text{m}$	CO <sub>2</sub>	0.34
Monochloroethane, C <sub>2</sub> H <sub>5</sub> Cl	10.275 $\mu\text{m}$	CO <sub>2</sub>	0.12
Ammonia, NH <sub>3</sub>	10.333 $\mu\text{m}$	CO <sub>2</sub>	1.0
Ethylene, C <sub>2</sub> H <sub>4</sub>	10.533 $\mu\text{m}$	CO <sub>2</sub>	1.19
Sulfur hexafluoride, SF <sub>6</sub>	10.551 $\mu\text{m}$	CO <sub>2</sub>	30.3

# Pollutant Gases in Earth Atmosphere

Note: the absorption cross-sections of molecules are about 6 orders of magnitude smaller than the metal atoms such as Na, Fe, K .

**Table 4.1** Absorption Cross Section of Pollutant Gases at Wavelengths Suitable for DIAL Measurement in the Troposphere—(Continued)

Molecule	Typical Wavelength	Laser (Examples)	Absorption Cross Section ( $10^{-18} \text{ cm}^2$ )
Trichloroethylene, C <sub>2</sub> HCl <sub>3</sub>	10.591 $\mu\text{m}$	CO <sub>2</sub>	0.49
1,2-Dichloroethane, C <sub>2</sub> H <sub>4</sub> Cl <sub>2</sub>	10.591 $\mu\text{m}$	CO <sub>2</sub>	0.02
Hydrazine, N <sub>2</sub> H <sub>4</sub>	10.612 $\mu\text{m}$	CO <sub>2</sub>	0.18
Vinyl chloride, C <sub>2</sub> H <sub>3</sub> Cl	10.612 $\mu\text{m}$	CO <sub>2</sub>	0.33
UDMH, (CH <sub>3</sub> ) <sub>2</sub> N <sub>2</sub> H <sub>2</sub>	10.696 $\mu\text{m}$	CO <sub>2</sub>	0.08
Fluorocarbon-12, CCl <sub>2</sub> F <sub>2</sub>	10.719 $\mu\text{m}$	CO <sub>2</sub>	1.33
Perchloroethylene, C <sub>2</sub> Cl <sub>4</sub>	10.742 $\mu\text{m}$	CO <sub>2</sub>	0.18
1-Butene, C <sub>4</sub> H <sub>8</sub>	10.787 $\mu\text{m}$	CO <sub>2</sub>	0.13
Perchloroethylene, C <sub>2</sub> Cl <sub>4</sub>	10.834 $\mu\text{m}$	CO <sub>2</sub>	1.14

# Lidar Detection of Constituents

Detection of constituents must be some kind of spectroscopy method, i.e., frequency or wavelength information is needed to identify special species. Usually, special laser frequency is required to perform such detection.

□ **Metal atoms in the middle and upper atmosphere, Helium and  $N_2^+$  in thermosphere:** density, abundance, temporal and spatial distributions, diurnal, seasonal and interannual variations; temperature, wind, waves

- resonance fluorescence lidar

□ **Molecular species in lower stratosphere and troposphere:**  $H_2O$ ,  $O_3$ ,  $NO_x$ ,  $SO_2$ ,  $Cl_2$ ,  $C_6H_6$ ,  $C_7H_8$ , VOC, HCl,  $SF_6$ ,  $NH_3$ , etc

- Differential Absorption Lidar (DIAL)

mainly Differential Absorption and Scattering Lidar (DAS)

- Raman Scattering Lidar

- Raman DIAL

- Multiwavelength DIAL

# Constituent Lidar Techniques

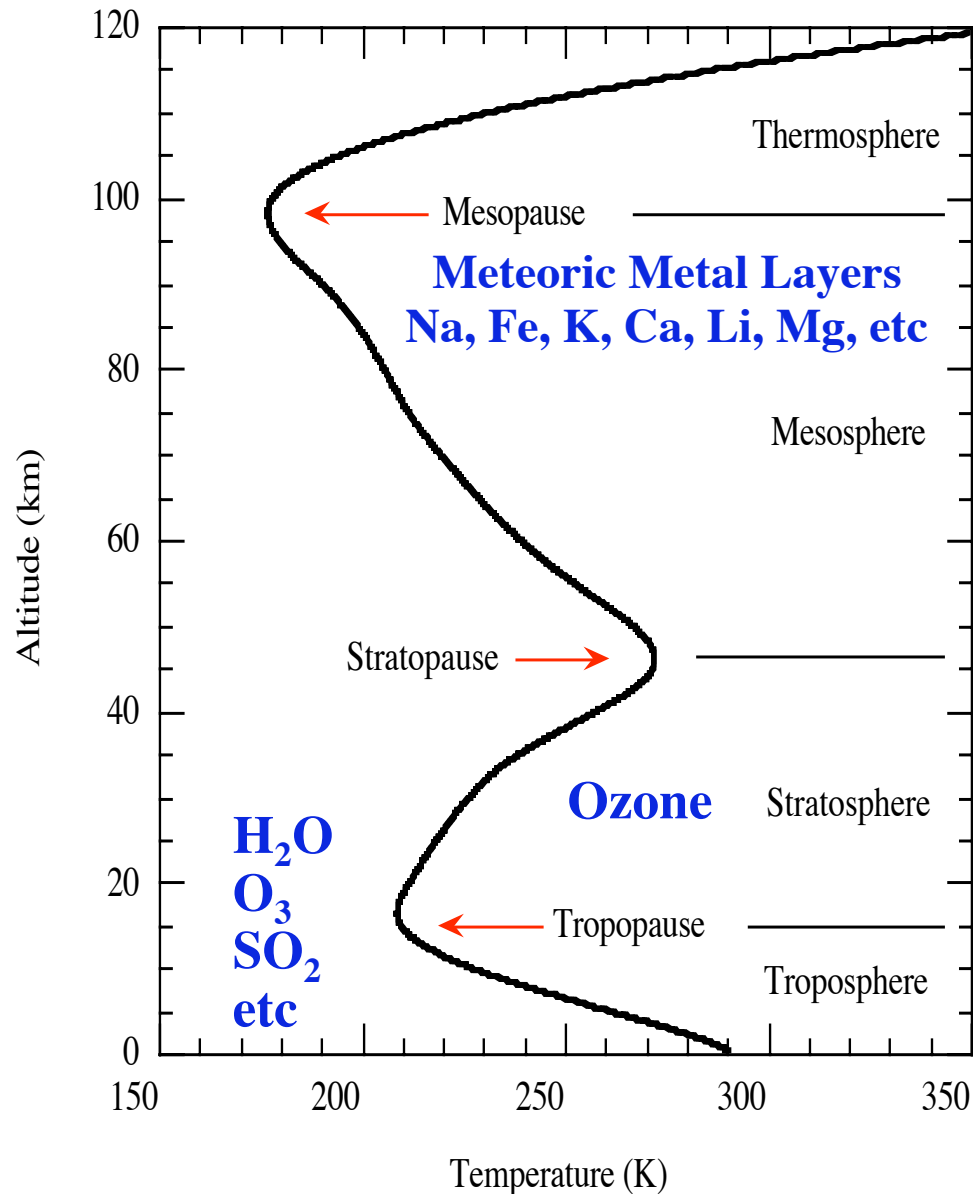

- ❑ He and N<sub>2</sub><sup>+</sup> in thermosphere: resonance fluorescence lidar
- ❑ O in thermosphere: resonance fluorescence lidar or DIAL from space
- ❑ Metal atoms in 75-120km: resonance fluorescence lidar (broadband or narrowband transmitter)
- ❑ Molecular species in lower stratosphere & troposphere: Differential absorption lidar (DIAL), Raman scattering lidar, Raman DIAL, Multi-channel DIAL



# Resonance Fluorescence Lidar Equation

- Fluorescence form of lidar equation

$$N_S(\lambda, z) = \left( \frac{P_L(\lambda)\Delta t}{hc/\lambda} \right) \left( \sigma_{eff}(\lambda, z)n_c(z)R_B(\lambda)\Delta z \right) \left( \frac{A}{4\pi z^2} \right) \left( T_a^2(\lambda, z)T_c^2(\lambda, z) \right) \left( \eta(\lambda)G(z) \right) + N_B$$

- Here, we would like to point out that the original  $E(R)$  should be given a better name like transmission through the constituent layer, i.e., it is the light transmission after the extinction by constituent absorption.

$$T_c(z) \equiv E(z) = \exp\left( - \int_{z_{bottom}}^z \sigma_{eff}(\lambda, z')n_c(z') dz' \right) = \exp\left( - \int_{z_{bottom}}^z \alpha_c(\lambda, z') dz' \right)$$

- Here,  $\alpha(\lambda, z)$  is the extinction coefficient caused by the absorption.

$$\alpha_c(\lambda, z) = \sigma_{eff}(\lambda, z)n_c(z)$$

- We rewrite the Rayleigh scattering form of lidar equation

$$N_R(\lambda, z_R) = \left( \frac{P_L(\lambda)\Delta t}{hc/\lambda} \right) \left( \sigma_R(\pi, \lambda)n_R(z_R)\Delta z \right) \left( \frac{A}{z_R^2} \right) T_a^2(\lambda, z_R) \left( \eta(\lambda)G(z_R) \right) + N_B$$

# Solution for Resonance Fluorescence

□ Through Rayleigh normalization, we obtain the solution of the lidar equation (i.e., the constituent number density) as below

$$n_c(z) = n_R(z_R) \frac{N_S(\lambda, z) - N_B}{N_R(\lambda, z_R) - N_B} \cdot \frac{z^2}{z_R^2} \cdot \frac{4\pi\sigma_R(\pi, \lambda)}{\sigma_{eff}(\lambda)R_B(\lambda)} \cdot \frac{1}{T_c^2(\lambda, z)}$$

□ To introduce the lidar equation for DIAL, we make a format change to resonance fluorescence lidar equation using the relationship below

$$\beta_{resfluo}(\lambda, \lambda_L, R) = \frac{\sigma_{eff}(\lambda_L, R)}{4\pi} n_c(R) R_B(\lambda)$$

□ Therefore, the resonance fluorescence lidar equation can be written as

$$N_S(\lambda, z) = \left( \frac{P_L(\lambda)\Delta t}{hc/\lambda} \right) \left( \beta_{resfluo}(\lambda, z)\Delta z \right) \left( \frac{A}{z^2} \right) T_a^2(\lambda, z) \exp\left( -2 \int_{z_{bottom}}^z \sigma_{eff}(\lambda, z') n_c(z') dz' \right) \left( \eta(\lambda)G(z) \right) + N_B$$

# Differential Absorption Lidar

- ❑ For the molecular species to be detected by DIAL, usually they have strong absorption, however, nearly none resonance fluorescence due to strong relaxation processes other than fluorescence (e.g., frequent collisions with surrounding atmosphere molecules can make molecules decay from excited states to ground state without giving fluorescence).
- ❑ Thus, in the lidar equation for DIAL, the influence of molecular species is in the extinction (atmosphere transmission) part, not in the backscatter part. In other words, the molecular absorption contributes to the extinction of light when incident light and scattered light propagate through atmosphere, while the return signals are from the scattering of laser light by air molecules and aerosols.

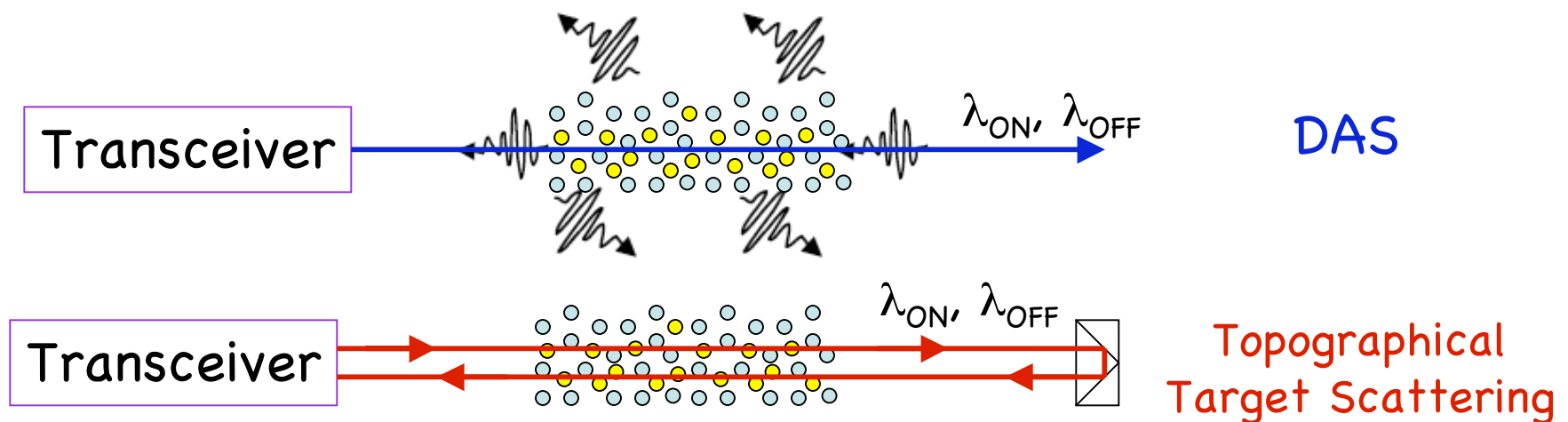

# Lidar Equation for DIAL

- DIAL lidar equation

$$P_S(\lambda, R) = P_L(\lambda) \left[ \beta_{scatter}(\lambda, R) \Delta R \right] \left( \frac{A}{R^2} \right) \exp \left[ -2 \int_0^R \bar{\alpha}(\lambda, r) dr \right] \\ \times \exp \left[ -2 \int_0^R \sigma_{abs}(\lambda, r) n_c(r) dr \right] \left[ \eta(\lambda) G(R) \right] + P_B$$

Extinction caused by interested constituent absorption

Extinction caused by other molecules and aerosols

- Compared to resonance fluorescence, the main difference in DIAL is that the backscatter coefficient is from the elastic-scattering from air molecules and aerosols, not from the fluorescence of interested molecules.

$$\beta_{Scatter}(\lambda, R) = \beta_{aer}(\lambda, R) + \beta_{mol}(\lambda, R)$$

- The parameter in the DIAL equation

$$\bar{\alpha}(\lambda, r) = \alpha_{aer}(\lambda, r) + \alpha_{mol}(\lambda, r) + \sigma_{IG}(\lambda, r) n_{IG}(r)$$

Aerosol Extinction

Air Molecule Extinction

Interference gas absorption

# DIAL Equation Cont'd

- ❑ Notice that the constituent information is already included in the extinction part. If the lidar parameters and aerosol/air molecule backscatter and extinction are known, we can derive the constituent number density from the lidar equation directly.
- ❑ Unfortunately, most of these parameters are unknown. So the DIAL technique is to utilize two wavelengths - one tuned to strong molecular absorption and another one detuned off the absorption line. Thus, most of the parameters can be cancelled or estimated to a much better degree, allowing the constituent information to be derived more truthfully.

$$P_S(\lambda_{ON}, R) = P_L(\lambda_{ON}) \left[ (\beta_{aer}(\lambda_{ON}, R) + \beta_{mol}(\lambda_{ON}, R)) \Delta R \right] \left( \frac{A}{R^2} \right) \exp \left[ -2 \int_0^R (\alpha_{aer}(\lambda_{ON}, r) + \alpha_{mol}(\lambda_{ON}, r)) dr \right] \\ \times \exp \left[ -2 \int_0^R \sigma_{IG}(\lambda_{ON}, r) n_{IG} dr \right] \exp \left[ -2 \int_0^R \sigma_{abs}(\lambda_{ON}, r) n_c(r) dr \right] \left[ \eta(\lambda_{ON}) G(R) \right] + P_B$$

$$P_S(\lambda_{OFF}, R) = P_L(\lambda_{OFF}) \left[ (\beta_{aer}(\lambda_{OFF}, R) + \beta_{mol}(\lambda_{OFF}, R)) \Delta R \right] \left( \frac{A}{R^2} \right) \exp \left[ -2 \int_0^R (\alpha_{aer}(\lambda_{OFF}, r) + \alpha_{mol}(\lambda_{OFF}, r)) dr \right] \\ \times \exp \left[ -2 \int_0^R \sigma_{IG}(\lambda_{OFF}, r) n_{IG} dr \right] \exp \left[ -2 \int_0^R \sigma_{abs}(\lambda_{OFF}, r) n_c(r) dr \right] \left[ \eta(\lambda_{OFF}) G(R) \right] + P_B$$

# Solution for DIAL Equations

□ To derive solution for DIAL equations, we take the ratio between the ON and OFF wavelength equations and take the logarithm of the ratio:

$$\ln \left[ \frac{P_S(\lambda_{ON}, R) - P_B}{P_S(\lambda_{OFF}, R) - P_B} \right] = \ln \left[ \frac{P_L(\lambda_{ON}) (\beta_{aer}(\lambda_{ON}, R) + \beta_{mol}(\lambda_{ON}, R)) \eta(\lambda_{ON})}{P_L(\lambda_{OFF}) (\beta_{aer}(\lambda_{OFF}, R) + \beta_{mol}(\lambda_{OFF}, R)) \eta(\lambda_{OFF})} \right]$$
$$- 2 \int_0^R [\alpha_{aer}(\lambda_{ON}, r) - \alpha_{aer}(\lambda_{OFF}, r)] dr$$
$$- 2 \int_0^R [\alpha_{mol}(\lambda_{ON}, r) - \alpha_{mol}(\lambda_{OFF}, r)] dr$$
$$- 2 \int_0^R [\sigma_{IG}(\lambda_{ON}, r) - \sigma_{IG}(\lambda_{OFF}, r)] n_{IG} dr$$
$$- 2 \int_0^R [\sigma_{abs}(\lambda_{ON}, r) - \sigma_{abs}(\lambda_{OFF}, r)] n_c(r) dr$$

□ Note: several factors have been eliminated from the equation:  $\Delta R$ ,  $A/R^2$ ,  $G(R)$ , as the ON and OFF wavelength laser lights are transmitted and received through the same transmitter and receiver, so share the same geometry factor and the same receiver aperture.

# Solution for DIAL Cont'd

□ Take the differentiation of the equation, we obtain the number density of the constituent that we are interested in

$$n_c(R) = \frac{1}{2\Delta\sigma_{abs}} \frac{d}{dR} \left\{ \begin{array}{l} \ln \left[ \frac{P_S(\lambda_{OFF}, R) - P_B}{P_S(\lambda_{ON}, R) - P_B} \right] \\ - \ln \left[ \frac{P_L(\lambda_{OFF})\eta(\lambda_{OFF})}{P_L(\lambda_{ON})\eta(\lambda_{ON})} \right] \\ - \ln \left[ \frac{\beta_{aer}(\lambda_{OFF}, R) + \beta_{mol}(\lambda_{OFF}, R)}{\beta_{aer}(\lambda_{ON}, R) + \beta_{mol}(\lambda_{ON}, R)} \right] \\ - 2[\alpha_{aer}(\lambda_{ON}, R) - \alpha_{aer}(\lambda_{OFF}, R)] \\ - 2[\alpha_{mol}(\lambda_{ON}, R) - \alpha_{mol}(\lambda_{OFF}, R)] \\ - 2[\sigma_{IG}(\lambda_{ON}, R) - \sigma_{IG}(\lambda_{OFF}, R)]n_{IG} \end{array} \right. \begin{array}{l} \text{---} \\ \text{---} \\ \text{---} \\ \text{---} \\ \text{---} \\ \text{---} \end{array} \begin{array}{l} \text{A} \\ \text{B} \\ \text{C} \\ \text{D} \\ \text{E} \\ \text{F} \end{array}$$

□ Here, the  $\Delta\sigma_{abs}$  is called the differential absorption cross-section

$$\begin{aligned} \Delta\sigma_{abs}(R) &= \sigma_{abs}(\lambda_{ON}, R) - \sigma_{abs}(\lambda_{OFF}, R) \\ &= \sigma_{abs}(\lambda_{ON}) - \sigma_{abs}(\lambda_{OFF}) \end{aligned}$$

# DIAL Solution in Simple Case

□ In the case that the ON and OFF wavelengths have small separation, the laser power, lidar efficiency, aerosol/molecule backscatter coefficient and extinction coefficient are close to be the same for the ON and OFF wavelengths. Therefore, terms B-E are zero. Also, assume there is no interference gas present, so term F is zero. Then we have

$$n_c(R) = \frac{1}{2\Delta\sigma_{abs}} \frac{d}{dR} \left\{ \ln \left[ \frac{P_S(\lambda_{OFF}, R) - P_B}{P_S(\lambda_{ON}, R) - P_B} \right] \right\}$$

□ In practice, lidar signals are not recorded or analyzed as continuous functions, but rather as values in discrete range bins. Thus, the above solution should be expressed in terms of a range increment  $\Delta R$ :

$$n_c(R) = \frac{1}{2\Delta\sigma_{abs}\Delta R} \ln \left[ \frac{P_S(\lambda_{OFF}, R + \Delta R) - P_B}{P_S(\lambda_{ON}, R + \Delta R) - P_B} \cdot \frac{P_S(\lambda_{ON}, R) - P_B}{P_S(\lambda_{OFF}, R) - P_B} \right]$$

□ Number density average between range  $R_1$  and  $R_2$

$$n_c = \frac{1}{2\Delta\sigma_{abs}\Delta R} \ln \left[ \frac{P_S(\lambda_{OFF}, R_2) - P_B}{P_S(\lambda_{ON}, R_2) - P_B} \cdot \frac{P_S(\lambda_{ON}, R_1) - P_B}{P_S(\lambda_{OFF}, R_1) - P_B} \right]$$



# Water Vapor Absorption Lines

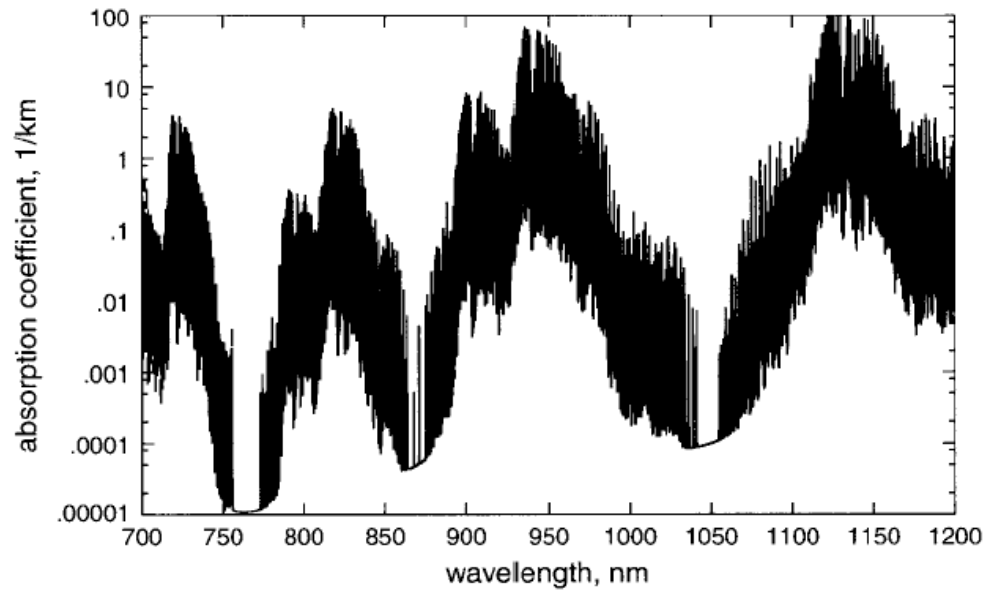

730 nm

820 nm

930 nm

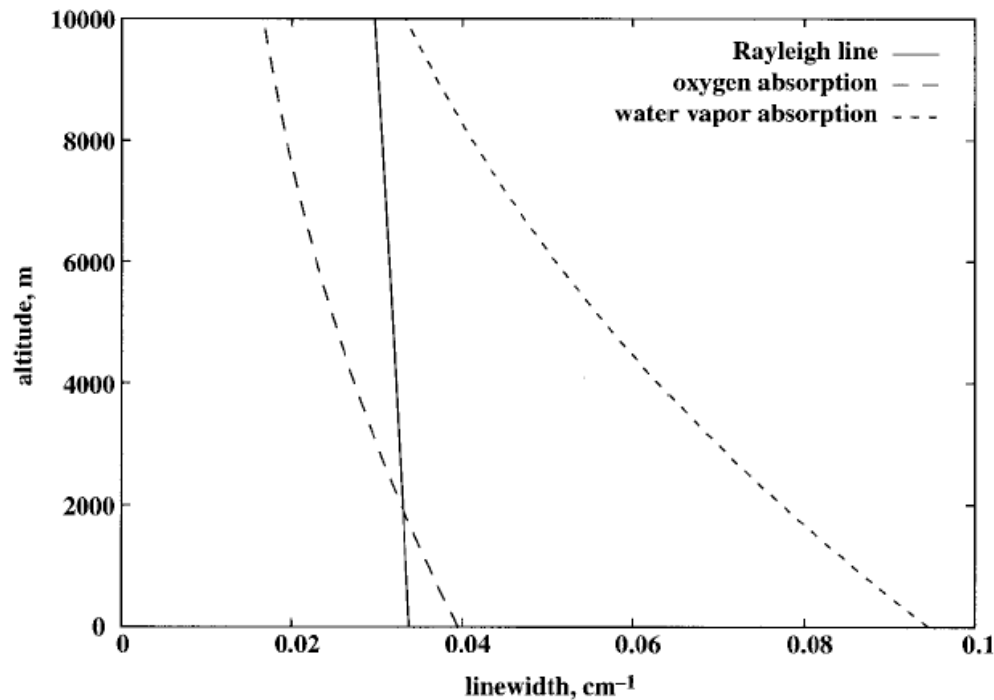

Doppler Broadened  
Absorption Lines

Fig. 8.2. Widths (HWHM) of the Rayleigh scattered line, the oxygen absorption line  $P_{27,27}$  at  $\nu_0 = 13010.81 \text{ cm}^{-1}$ , and the  $\text{H}_2\text{O}$  absorption line at  $\nu_0 = 13718.58 \text{ cm}^{-1}$ .

# NOAA Water Vapor DIAL

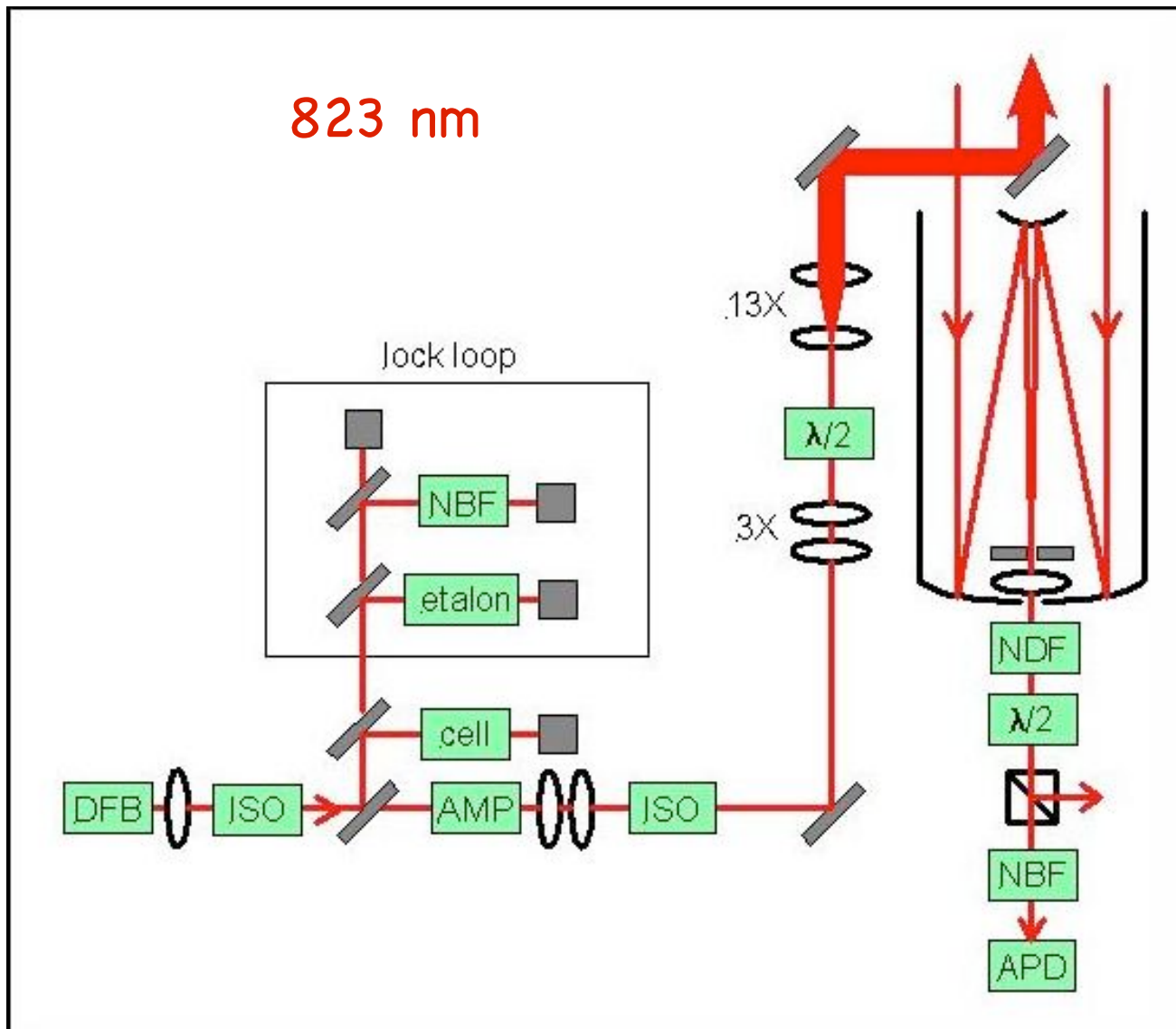

System Schematic

# NOAA Water Vapor DIAL

## Sampling Result

### Specifications

wavelength	823 nm
seed power	16 mW
amplifier peak power	0.5 W
output pulse energy	$\sim 0.15 \mu\text{W}$
pulse duration	600 ns (adjustable)
pulse repetition freq.	8 kHz (adjustable)
telescope diameter	34 cm
field-of-view	$180 \mu\text{Rad}$

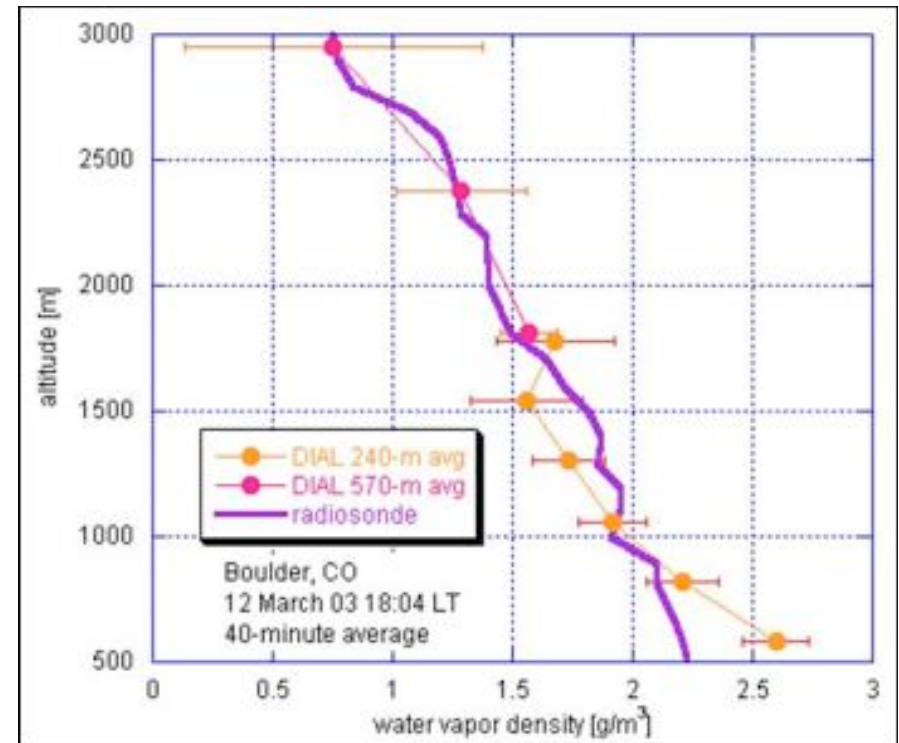

# Summary

- ❑ Atmospheric constituents are important trace gases that are closely related to global climate change, air quality and pollution, atmosphere energy budget, and atmospheric thermal structure, dynamics, and chemistry.
- ❑ Lidar techniques provide one of the best ways to monitor atmospheric constituents with high resolution and accuracy.
- ❑ Among them, resonance fluorescence lidar, differential absorption lidar, and Raman lidar are the most promising techniques for constituent measurements.
- ❑ DIAL involves lots of parameters in its lidar equation. For simple case where the ON and OFF wavelengths have small separation, the problem can be dramatically simplified. More considerations are required when dealing with other cases.